

TASCAM

DR-07MKII

Linear PCM Recorder

This device has a serial number located inside the battery compartment. Please record it and retain it for your records.

Serial number:

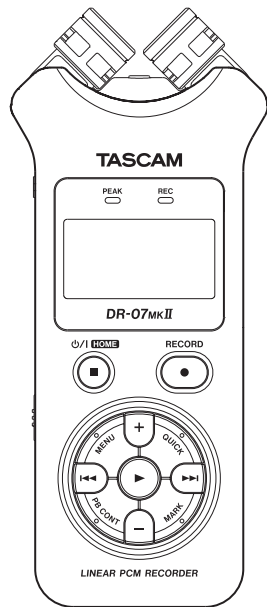

OWNER'S MANUAL

IMPORTANT SAFETY INSTRUCTIONS

- 1 Read these instructions.
- 2 Keep these instructions.
- 3 Heed all warnings.
- 4 Follow all instructions.
- 5 Do not use this apparatus near water.
- 6 Clean only with dry cloth.
- 7 Do not block any ventilation openings. Install in accordance with the manufacturer's instructions.
- 8 Do not install near any heat sources such as radiators, heat registers, stoves, or other apparatus (including amplifiers) that produce heat.
- 9 Do not defeat the safety purpose of the polarized or grounding-type plug. A polarized plug has two blades with one wider than the other. A grounding type plug has two blades and a third grounding prong. The wide blade or the third prong are provided for your safety. If the provided plug does not fit into your outlet, consult an electrician for replacement of the obsolete outlet.
- 10 Protect the power cord from being walked on or pinched particularly at plugs, convenience receptacles, and the point where they exit from the apparatus.
- 11 Only use attachments/accessories specified by the manufacturer.
- 12 Use only with the cart, stand, tripod, bracket, or table specified by the manufacturer, or sold with the apparatus.

When a cart is used, use caution when moving the cart/apparatus combination to avoid injury from tip-over.



- 13 Unplug this apparatus during lightning storms or when unused for long periods of time.
 - 14 Refer all servicing to qualified service personnel. Servicing is required when the apparatus has been damaged in any way, such as power-supply cord or plug is damaged, liquid has been spilled or objects have fallen into the apparatus, the apparatus has been exposed to rain or moisture, does not operate normally, or has been dropped.
- Do not expose this apparatus to drips or splashes.
 - Do not place any objects filled with liquids, such as vases, on the apparatus.
 - Do not install this apparatus in a confined space such as a book case or similar unit.
 - If the product uses batteries (including a battery pack or installed batteries), they should not be exposed to sunshine, fire or excessive heat.

IMPORTANT SAFETY INSTRUCTIONS

- CAUTION for products that use replaceable lithium batteries: there is danger of explosion if a battery is replaced with an incorrect type of battery. Replace only with the same or equivalent type.
- Caution should be taken when using earphones or headphones with the product because excessive sound pressure (volume) from earphones or headphones can cause hearing loss.

Cautions about Batteries

This product uses batteries. Misuse of batteries could cause a leak, rupture or other trouble. Always abide by the following precautions when using batteries.

- Never recharge non-rechargeable batteries. The batteries could rupture or leak, causing fire or injury.
- When installing batteries, pay attention to the polarity indications (plus/minus (+/-) orientation), and install them correctly in the battery compartment as indicated. Putting them in backward could make the batteries rupture or leak, causing fire, injury or stains around them.
- When you store or dispose of batteries, isolate their terminals with insulation tape or something like that to prevent them from contacting other batteries or metallic objects.
- When throwing used batteries away, follow the disposal instructions indicated on the batteries and the local disposal laws.
- Do not use batteries other than those specified. Do not mix and use new and old batteries or different types of batteries together. The batteries could rupture or leak, causing fire, injury or stains around them.
- Do not carry or store batteries together with small metal objects. The batteries could short, causing leak, rupture or other trouble.
- Do not heat or disassemble batteries. Do not put them in fire or water. Batteries could rupture or leak, causing fire, injury or stains around them.
- If the battery fluid leaks, wipe away any fluid on the battery case before inserting new batteries. If the battery fluid gets in an eye, it could cause loss of eyesight. If fluid does enter an eye, wash it out thoroughly with clean water without rubbing the eye and then consult a doctor immediately. If the fluid gets on a person's body or clothing, it could cause skin injuries or burns. If this should happen, wash it off with clean water and then consult a doctor immediately.
- The unit power should be off when you install and replace batteries.
- Remove the batteries if you do not plan to use the unit for a long time. Batteries could rupture or leak, causing fire,

IMPORTANT SAFETY INSTRUCTIONS

injury or stains around them. If the battery fluid leaks, wipe away any fluid on the battery compartment before inserting new batteries.

THIS CLASS B DIGITAL APPARATUS COMPLIES WITH
CANADIAN ICES-003.
CET APPAREIL NUMÉRIQUE DE LA CLASSE B EST CONFORME
À LA NORME NMB-003 DU CANADA.

FOR U.S.A.

TO THE USER

This equipment has been tested and found to comply with the limits for a Class B digital device, pursuant to Part 15 of the FCC Rules. These limits are designed to provide reasonable protection against harmful interference in a residential installation. This equipment generates, uses, and can radiate radio frequency energy and, if not installed and used in accordance with the instruction manual, may cause harmful interference to radio communications. However, there is no guarantee that interference will not occur in a particular installation. If this equipment does cause harmful interference to radio or television reception, which can be determined by turning the equipment off and on, the user is encouraged to try to correct the interference by one or more of the following measures.

- a) Reorient or relocate the receiving antenna.
- b) Increase the separation between the equipment and receiver.
- c) Connect the equipment into an outlet on a circuit different from that to which the receiver is connected.
- d) Consult the dealer or an experienced radio/TV technician for help.

CAUTION

Changes or modifications to this equipment not expressly approved by TEAC CORPORATION for compliance could void the user's authority to operate this equipment.

■ For European Customers

Disposal of electrical and electronic equipment

- (a) All electrical and electronic equipment should be disposed of separately from the municipal waste stream via collection facilities designated by the government or local authorities.
- (b) By disposing of electrical and electronic equipment correctly, you will help save valuable resources and prevent any potential negative effects on human health and the environment.
- (c) Improper disposal of waste electrical and electronic equipment can have serious effects on the environment and human health because of the presence of hazardous substances in the equipment.
- (d) The Waste Electrical and Electronic Equipment (WEEE) symbol, which shows a wheeled bin that has been crossed out, indicates that electrical and electronic equipment must be collected and disposed of separately from household waste.



- (e) Return and collection systems are available to end users. For more detailed information about the disposal of old electrical and electronic equipment, please contact your city office, waste disposal service or the shop where you purchased the equipment.

Disposal of batteries and/or accumulators

- (a) Waste batteries and/or accumulators should be disposed of separately from the municipal waste stream via collection facilities designated by the government or local authorities.
- (b) By disposing of waste batteries and/or accumulators correctly, you will help save valuable resources and prevent any potential negative effects on human health and the environment.
- (c) Improper disposal of waste batteries and/or accumulators can have serious effects on the environment and human health because of the presence of hazardous substances in them.

Safety Information

- (d) The WEEE symbol, which shows a wheeled bin that has been crossed out, indicates that batteries and/or accumulators must be collected and disposed of separately from household waste.



Pb, Hg, Cd

If a battery or accumulator contains more than the specified values of lead (Pb), mercury (Hg), and/or cadmium (Cd) as defined in the Battery Directive (2006/66/EC), then the chemical symbols for those elements will be indicated beneath the WEEE symbol.

- (e) Return and collection systems are available to end users. For more detailed information about the disposal of waste batteries and/or accumulators, please contact your city office, waste disposal service or the shop where you purchased them.

产品有毒有害物质或元素的名称及含量

机种：DR-07MKII		有毒有害物质或元素					
	品名	铅 (Pb)	汞 (Hg)	镉 (Cd)	六价铬 (Cr(VI))	多溴联苯 (PBB)	多溴二苯醚 (PBDE)
1	CHASSIS部份	○	○	○	○	○	○
2	PCB Assy部份	×	○	○	○	○	○
3	线材部份	○	○	○	○	○	○
4	附属品部份	×	○	○	○	○	○
7	SEAL部份	○	○	○	○	○	○
8	包装部份	○	○	○	○	○	○

○：表示该有毒有害物质在该部件所有均质材料中的含量均在 SJ/T11363-2006 标准规定的限量要求以下。

×：表示该有毒有害物质至少在该部件的某一均质材料中的含量超出 SJ/T11363-2006 标准规定的限量要求。

(针对现在代替技术困难的电子部品及合金中的铅)

Table of Contents

Quick Start Guide	11	Basic operation.....	37
1-Introduction	14	3-Preparation.....	38
Features.....	14	Powering the unit.....	38
Items included with the product.....	16	Using AA batteries	38
Conventions used in this manual	17	Using an AC adaptor (sold separately)	38
Intellectual property rights	18	Using USB bus power.....	39
About microSD cards	20	Start-up & shutdown	40
Precautions for placement.....	20	Starting up the unit	40
Beware of condensation.....	21	Shutting down	41
Cleaning the unit	21	Resume function	41
Product Registration	21	Setting the date and time	42
2-Names and Functions of Parts	22	Inserting and removing microSD cards	43
Top panel	22	Inserting the microSD card.....	43
Front panel.....	26	Removing the card	43
Rear panel	26	Preparing a microSD card for use.....	44
Left side panel	27	Using the built-in speaker	45
Right side panel	27	Connecting monitors and headphones	46
Bottom Panel	28	Using the built-in microphone	46
Home Screen.....	29	Setting the mics to record a wide stereo	
Recording Screen	32	sound (A-B position)	46
Playback Control screen.....	34	Setting the mics to record a clear stereo	
Menu item list.....	35	sound (X-Y position)	47
Using menus.....	36	Swapping the left-right channels of the	
		built-in microphone pair	48

Table of Contents

Microphone position detection	49
4–Recording	50
Selecting file format/sampling frequency/ type, and maximum file size	50
Set where to save the file	52
Setting the input functions	52
Placing the unit and making connections	54
Recording with the built-in mics	54
Recording with external mics (MIC IN).....	54
Recording an external device (EXT IN).....	54
Adjusting the input level	55
Manually adjusting the input level.....	55
Using the Level Control Function	57
Recording	59
Recording playback and input sounds together (overdubbing)	60
Select the file you want to overdub.....	61
Selecting file format.....	61
Simultaneous listening to playback and input sound (Monitor Mix).....	62
Adjusting the input level (simple adjustment)	63
Start the overdubbing.....	65
Recording automatically (AUTO REC)	66
Creating and changeover to a new file during continued recording (Track incrementing)	68
Manual track incrementation during recording	68
Automatic track incrementation by file size ...	69
Mark function.....	70
Adding marks manually to a recording	70
Adding marks automatically to a recording ...	71
Moving to a mark position.....	71
Recording the moment before pushing RECORD (PRE REC).....	72
Self-timer function.....	73
Recording duration.....	74
5–Working with Files and Folders (BROWSE screen)	75
Screen navigation	75
Icons on the BROWSE screen	76
File operations.....	77
Folder operations	78
Creating a new folder	79
6–Playback	80
Adjusting playback volume.....	80

Table of Contents

Setting the playback area (AREA).....	80	Deleting the selected file (Quick Delete)....	97
Selecting a folder for the playback area (1)....	82	Dividing the selected file (DIVIDE).....	97
Selecting a folder for the playback area (2) ...	83	Increasing the perceived overall sound pressure to enhance listenability (Level Alignment)	99
Playlist.....	84	8-Using the Effects	101
Adding tracks to the playlist	84	Setting the effect.....	101
Editing the playlist	85	Effects Preset List.....	102
Selecting files for playback (skip).....	87	9-Tuning a Musical Instrument (Tuner) ...	103
Playback.....	87	Using the tuner.....	103
Pausing.....	87	Setting the tuner	103
Stopping	87	Tuning a musical instrument	103
Rewinding and fast-forwarding (search)....	88	Adjusting the input level for tuning.....	103
Repeat playback (REPEAT).....	88	10-Connecting with a computer	104
Special Playback Control Functions	89	Transferring files to a computer.....	105
Playback Control Screen.....	89	Transferring files from a computer.....	106
Repeated Playback of Selection (Loop Playback)	90	Disconnecting from a computer	106
Changing the playback speed (VSA).....	91	11-Settings and Information	107
Using the playback equalizer (PLAY EQ)	92	Viewing File Information	107
Moving back a few seconds for replay (jump-back playback)	93	File information page	107
7-Quick Operations	94	Card information page.....	108
Features of the QUICK button	94	System information page.....	108
Quick menu screen.....	95	System Settings and Formatting.....	109
Closing the Quick menu screen.....	97		

Table of Contents

Turning the unit power OFF automatically ...	109
Setting the backlight	109
Adjusting the display contrast	110
Setting the type of AA batteries.....	110
Restoring the factory settings.....	110
Using QUICK FORMAT	110
Using FULL FORMAT	111
Setting the format of file names.....	112
File name format	112
Setting the WORD item.....	112
12–Messages.....	113
13–Troubleshooting.....	117
14–Specifications	119
Ratings	119
Input/output ratings	119
Analog audio input/output ratings.....	119
Control input/output ratings.....	119
Audio performance	120
Computer compatibility	120
Other specifications	121
Dimensional drawings.....	123

Quick Start Guide

Try recording and playback with TASCAM DR-07MKII.

The unit contains a factory-installed microSD card, and will by default produce 44.1kHz, 16-bit WAV files.

Higher-quality or longer files can be produced using other recording settings. See “Selecting file format/sampling frequency/type, and maximum file size” for details on page 50.

- 1 Install batteries in the battery compartment on the back of the unit. Fit them to the + and – marks shown in the compartment.**

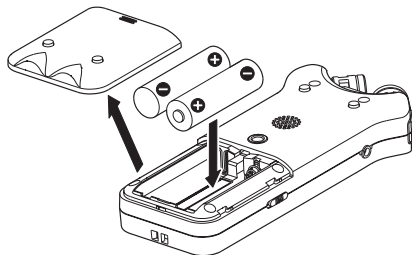

- 2 Turn on, and various setting information will be displayed.**

Press the $\odot / |$ (HOME) \blacksquare button until the unit is turned on, and then release it.

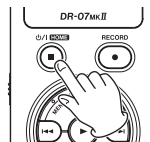

CAUTION

The first time you use the unit, a built-in clock setting screen will appear.



Press the \lll or \ggg button to move the cursor (highlighted portion), and adjust the date and time using the + or - button. Then press the \triangleright button to set.

Quick Start Guide

- 3 Press the RECORD [●] button to switch to recording standby. The REC indicator will flash.

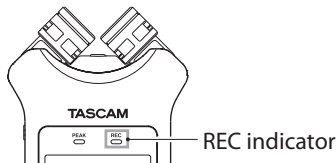

NOTE

If the **L-R** or **R-L** icon appears in the upper right of the Home Screen, the adjustment for the angle and the left-right channels of the microphone do not suit the recording setting. Change the settings. (See "Using the built-in microphone" on page 46.)

- 4 Use the **◀◀** or **▶▶** button to adjust the recording level. See "Adjusting the input level" on page 55 for details.
- 5 Press the RECORD [●] button to start recording. The REC indicator will light during recording.
- 6 Press the **⏻** / **|** (HOME) [■] button to finish recording.



NOTE

To pause recording, press the RECORD [●] button. Press the RECORD [●] button again to restart recording in the same track.

- 7 Press the **▶** button for playback. If you use a headphone or amplifier/speaker set, connect it to the Ω /LINE OUT socket on the left side panel.

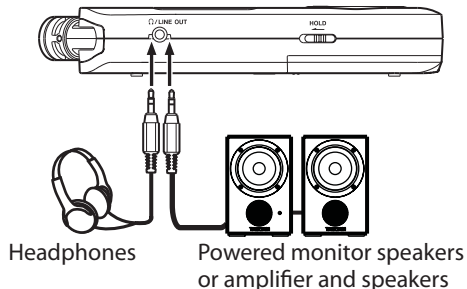
For playback over the built-in speaker set, enable it on the speaker settings screen (See "Using the built-in speaker" on page 45.)



- 8 Use the + or – button to control the playback volume.
- 9 Press the  / | (HOME) [] button to stop playback.

NOTE

If you have made several recordings, use the  or  button to select the file to play when playing back or stopped and the Home Screen is displayed.

1-Introduction

Thank you very much for purchasing the TASCAM DR-07MKII Linear PCM Recorder. Please read this Owner's Manual carefully in order to maximize your use of all the unit's features. We hope that you will enjoy using this recorder for many years to come.

After you have finished reading this manual, please keep it in a safe place for future reference.

You can also download the Owner's Manual from the TASCAM web site (<http://tascam.com/>).

Features

- Compact audio recorder that uses microSD/microSDHC cards as recording media
- Cardioid stereo microphones allow high-quality stereo recording
- Can record with different types of stereo sound depending on the angle of the microphones
 - Close: Clear Stereo Sound with less phase difference
 - Open: Wide Stereo Sound
- 44.1/48/96 kHz, 16/24-bit, linear PCM (WAV format) recording possible
- Compatible with WAV files in BWF format
- 32–320 kbps MP3 format recording possible (compatible with ID3 tag v2.4)
- Overdubbing allows playback and input signals to be mixed and recorded together as a new file
- Built-in 0.3 W monaural output speaker
- Built-in effect (reverb) can be used during recording and playback
- Auto-record function starts recording automatically when a set sound input level is detected
- Can start recording a new file automatically when a maximum file size set in advance is reached without interrupting recording

- A QUICK button is available for easy access to various functions
- Track incrementing function allows a recording to be split by creating a new file when desired
- Pre-recording (PRE REC) function allows the unit to record the 2 seconds of sound before recording is activated
- Peak reduction function is available to reduce the level automatically in case of excessively large input.
- Automatic level control is available to increase or decrease the recording volume when the input sound is too low or too high, respectively.
- Limiter function automatically reduces the level suitably in particular portions where the input level is too high
- Low cut filter conveniently reduces low-frequency noise
- VSA function can change the playback speed in the range from 0.5 to 1.5 times (in 0.1 increments) the normal speed without changing pitch
- Repeat playback and IN-OUT loop playback functions
- PB CONTROL button is available to show settings screens for playback speed control and IN-OUT loop
- Tuner function to tune musical instruments
- Self-timer function to start recording after a set period of time.
- Jump back and play function allows the last several seconds of the currently played file to be replayed again by simply pressing a button
- REC DELAY function can be used to avoid recording the sound of pressing the **RECORD** button
- Playlist function
- DIVIDE function allows files to be split where desired (only for WAV files)
- MARK function convenient for moving to specific locations

1-Introduction

- Equalizers function for playback, and level alignment function to enhance the perceived overall sound pressure
- File name format can be set to use a user-defined word or the date
- Resume function to memorize the playback position before the unit is turned off.
- 3.5mm (1/8") jack for external stereo microphone input (provides plug-in power) or external stereo line input
- 3.5mm (1/8") line/headphones output jack
- 128 x 64 pixel LCD with backlight
- Mini-B type USB 2.0 port
- Operates on 2 AA batteries, an AC adaptor (sold separately: TASCAM PS- P515U), or USB bus power
- Tripod attachment screw-hole built into unit
- USB cable included

Items included with the product

The DR-07MKII package contains the following items.

Take care when opening the package not to damage the items. Keep the package materials for transportation in the future.

Please contact the store where you purchased this unit if any of these items are missing or have been damaged during transportation.

- Main unit 1
- microSD card (in the unit) 1
- AA alkaline batteries 2
- USB cable (80 cm)..... 1
- Warranty card 1
- Owner's Manual (this document) 1

Conventions used in this manual

The following conventions are used in this manual.

- When we refer to a button or connector or control on the DR-07MKII, the typeface looks like this: **MENU**.
- When we show messages, for example, that appears on the screen, the typeface looks like this: **ON**.
- “microSD memory card” is sometimes abbreviated as “microSD card”.
- Additional information is introduced in the styles below when needed:

TIP

We give hints and tips on using the DR-07MKII when you see this icon.

NOTE

A note provides additional explanations for special situations.

CAUTION

A caution shows that you may lose data (recordings) if you do not follow the instructions.

1-Introduction

Intellectual property rights

- TASCAM is a registered trademark of TEAC Corporation.
- microSDHC Logo is a trademark of SD-3C, LLC.



- Supply of this product does not convey a license nor imply any right to distribute MPEG Layer-3 compliant content created with this product in revenue-generating broadcast systems (terrestrial, satellite, cable and/or other distribution channels), streaming applications (via Internet, intranets and/or other networks), other content distribution systems (pay-audio or audio-on-demand applications and the like) or on physical media (compact discs, digital versatile discs, semiconductor chips, hard drives,

memory cards and the like). An independent license for such use is required. For details, please visit <http://mp3licensing.com>.

- MPEG Layer-3 audio coding technology licensed from Fraunhofer IIS and Thomson.
- Microsoft, Windows, Windows XP, Windows Vista, and Windows 7 are either registered trademarks or trademarks of Microsoft Corporation in the United States and/or other countries.
- Apple, Macintosh, iMac, Mac OS and Mac OS X are trademarks of Apple Inc.

Other company names, product names and logos in this document are the trademarks or registered trademarks of their respective owners.

Any data, including, but not limited to information, described herein are intended only as illustrations of such data and/or information and not as the specifications for such data and/or information. TEAC Corporation disclaims any warranty that any use of such data and/or information shall be free from infringement of any third party's intellectual property rights or other proprietary rights, and further, assumes no liability of whatsoever nature in the event of any such infringement, or arising from or connected with or related to the use of such data and/or information.

This product is designed to help you record and reproduce sound works to which you own the copyright, or where you have obtained permission from the copyright holder or the rightful licensor. Unless you own the copyright, or have obtained the appropriate permission from the copyright holder or the rightful licensor, your unauthorized recording, reproduction or distribution thereof may result in severe criminal penalties under copyright laws and international copyright treaties. If you are uncertain about your rights, contact your legal advisor. Under no circumstances will TEAC Corporation be responsible for the consequences of any illegal copying performed using the recorder.

1-Introduction

About microSD cards

This unit uses microSD cards for recording and playback. microSD cards that are 64 MB - 2 GB and microSDHC cards that are 4 GB - 32 GB in size can be used. A list of microSD cards that have been tested with this unit can be found on the TASCAM web site (<http://tascam.com/>).

■ Precautions for use

microSD cards are delicate media. In order to avoid damaging a card or the card slot, please take the following precautions when handling them.

- Do not leave them in extremely hot or cold places.
- Do not leave them in extremely humid places.
- Do not let them get wet.
- Do not put things on top of them or twist them.
- Do not hit them.

Precautions for placement

- The environmental temperature operation range of this unit is 0–40° C (32–104° F).
- Do not install in the following types of places. Doing so could degrade the sound quality and/or cause malfunctions.
- Places with significant vibrations or that are otherwise unstable
- Near windows or other places exposed to direct sunlight
- Near heaters or other extremely hot places
- Extremely cold places
- Places with bad ventilation or high humidity

Beware of condensation

If the unit is moved from a cold to a warm place, or used after a sudden temperature change, there is a danger of condensation; vapor in the air could condense on the internal mechanism, making correct operation impossible. To prevent this, or if this occurs, let the unit sit for one or two hours at the new room temperature before using.

Cleaning the unit

Use a dry soft cloth to wipe the unit clean. Do not clean the unit with a chemically treated cloth or substances such as benzene, thinner and alcohol because they might cause damage to the surface of the unit.

Product Registration

Customers in the USA, please register your product online at tascam.com.

Click on "Product Registration" on the bottom of the homepage.

2-Names and Functions of Parts

Top panel

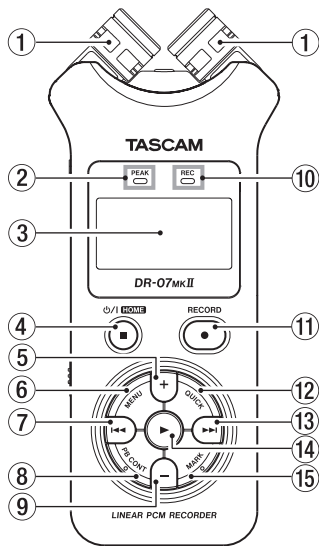

① Built-in stereo microphone

Cardioid stereo electret condenser microphone. You can set the microphone angles to open (A-B), or close (X-Y). If you connect an external microphone or external input to the MIC/EXT IN jack on the rear panel, the built-in microphone becomes inactive.

② PEAK indicator

Lights when the input volume is too high.

③ Display

Shows a variety of information.

④ \mathbb{H} /I (HOME) [■] button

Press this button during playback to cause the playback to pause at the current position. Press this button during pause time to return to the beginning of the track.

Press this button during recording or recording standby to cause the recording to stop.

When any other screen is open, press this button to return to the Home Screen. Use

2-Names and Functions of Parts

this button to answer “NO” to a confirmation message.

Press and hold this button to turn the unit’s power ON or OFF.

⑤ **+ button**

When the Home or TUNER screen is displayed, press this button to increase the output level from the built-in speaker or Ω/LINE OUT jack. During adjustment, a volume indicator will be displayed in a pull-up window.

When the Playback Control screen is displayed, press this button to increase the playback speed.

When a setting screen is open, use the button to change the setting of the selected item.

⑥ **MENU button**

When the Home Screen is displayed, press this button to open the MENU Screen.

Press this button to return to the MENU Screen from the various setting screens.

When the MENU Screen is displayed, press this button to return to the Home Screen.

When the IN and OUT points are set in the track and the Playback Control screen is displayed, press this button to turn on or off loop playback.

⑦ **◀◀ button**

Press this button to return to the beginning of a track that is playing or stopped in the middle. When the IN and OUT points are set between the current position and the beginning of the track, pressing this button skips to those points.

If you press this button when a track is stopped at its beginning, the unit will skip to the beginning of the previous track.

Press and hold this button to search backwards.

Press this button while pressing and holding the **MARK** button to return to the previous mark.

2-Names and Functions of Parts

On the setting screens, use this button to move the cursor left. On the **BROWSE** Screen, press this button to move up a level.

Press this button during recording or recording standby to decrease the input level from the built-in microphone or MIC/EXT IN jack. During adjustment, a pull-up window is shown in the display.

⑧ **PB CONT button**

This button activates the Playback Control screen. When the Playback Control screen is displayed, press this button to return to the Home Screen.

Press this button during recording standby to turn off the self-timer function or change the time period.

⑨ **- button**

When the Home Screen or the **TUNER** screen is displayed, press this button to decrease the output level from the built-in speaker or Ω/LINE OUT jack. During adjustment, a volume indicator will be displayed in a pull-up window.

When the Playback Control screen is open, press this button to decrease the playback speed.

When a setting screen is open, use the button to change the setting of the selected item.

⑩ **REC indicator**

The indicator flashes during recording standby. The indicator lights while recording.

⑪ **RECORD [●] button**

When stopped, press this button to put the unit into recording standby. REC indicator starts to flash. When **INPUT** is ON on the **MONITOR MIX** screen (**MONITOR MIX** is ON), a pop-up menu appears to ask whether overdubbing is ON/OFF.

When in standby, press this button to start recording, and the REC indicator lights.

When recording, press this button to pause recording.

2-Names and Functions of Parts

⑫ **QUICK button**

When playing back, stopped, paused or in recording standby in the Home Screen or when the Playback Control screen is displayed, press this button to display the Quick Menu screen. The function to be shown depends on the state of the unit when the button is pressed.

- Stopped: delete, division, or level alignment for the current song
- Playback/Playback Control screen: level alignment
- Recording standby: level control

Press this button to divide the recording by creating a new file.

When the **BROWSE** screen or **PLAYLIST** screen is displayed, press this button to show or cancel the popup menu for file/folder operations.

⑬ **▶▶ button**

Press this button during playback or when playback is stopped to skip to beginning of

the next track. When the IN and OUT points are set between the current position and the end of the track, pressing this button skips to those points.

Press and hold this button to search forward. On the setting screens, use this button to move the cursor right.

Press this button while pressing and holding the **MARK** button to move to the next mark. On the Browse Screen, press this button to move down a level. If a file is selected, the file is loaded and the unit returns to the Home Screen.

Press this button during recording or recording standby to increase the input level from the built-in microphone or MIC/EXT IN jack. During adjustment, a pull-up window is shown in the display.

⑭ **▶ button**

When the Home Screen is displayed and playback is stopped, press this button to start playback.

2-Names and Functions of Parts

During playback, press this button to start jump-back playback.

When a setting screen is open, use this to confirm selections.

When a file or folder is selected in the BROWSE screen, press this button to return to the Home Screen and play the file or the first file in the folder from the beginning.

15 MARK button

When recording, use it to add markers manually.

Press the ◀◀ or ▶▶ button while pressing and holding this button to move to the previous or next mark, respectively.

When the Playback Control screen is open, use this button to set the IN (start) and OUT (end) points of the interval that you want to set for loop playback. When the IN and OUT points are already set, press this button to cancel loop playback and clear the IN and OUT points.

Front panel

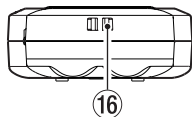

16 Strap attachment

Use this to attach a strap.

Rear panel

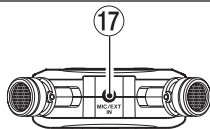

17 MIC/EXT IN jack

Use this input jack to connect a stereo mini-jack microphone or an external input device. This jack provides plug-in power when set to do so on the Input Setting Screen.

The built-in microphone is disabled if an external microphone is connected to the MIC/EXT IN jack.

2-Names and Functions of Parts

Left side panel

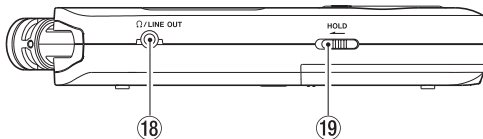

⑱ **Ω/LINE OUT jack**

Use this to connect with headphones or the line input jack of an amp or other equipment.

⑲ **HOLD switch**

Shift to the left end (in the direction of the arrow) to engage the hold function.

All buttons are inoperative when hold is ON.

Right side panel

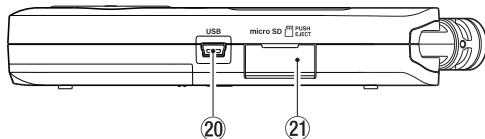

⑳ **USB port**

Use the included USB cable to connect with a computer USB port.

Power can be supplied through the USB cable provided with the unit or an AC adaptor (sold separately: TASCAM PS-P515U).

㉑ **microSD card slot**

Insert a microSD card into this slot.

2-Names and Functions of Parts

Bottom Panel

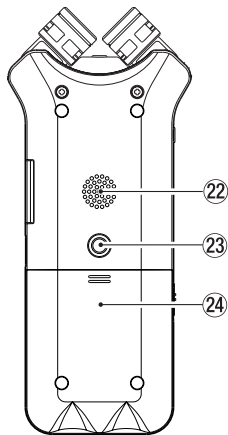

22 Mono speaker

Use this built-in speaker to listen to recordings.

Sound is not output during recording, when the unit is in recording standby, when

headphones are connected, when the speaker is disabled, or when Monitor Mix is enabled.

23 Tripod attachment screw-hole (1/4-inch)

Use this to attach the unit to a tripod or mic stand.

CAUTION

- Tighten the unit securely to the tripod or microphone stand to prevent it from falling off.
- Place the tripod or microphone stand on a level surface when using it with this unit.

24 Battery compartment cover

25 Battery compartment

Install batteries (2 AA) in this compartment to power the unit. (See "Using AA batteries" on page 38.)

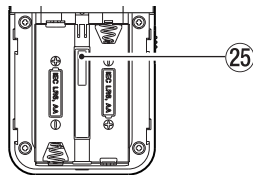

2-Names and Functions of Parts

Home Screen

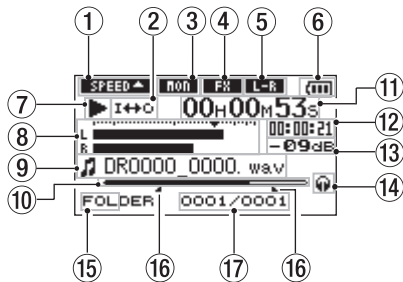

① Playback speed setting status

Icon	Playback speed
	x1.0
	x1.1 - x1.5
	x0.5 - x0.9
	Playback speed not controllable

② Loop/repeat playback status

- : Single playback
- : Single track repeat playback
- : All track repeat playback
- : Loop playback

③ Monitor Mix setting status

On/off status of Monitor Mix is shown.

- : Monitor Mix off
- : Monitor Mix on

④ Effect status

Shows whether the effect function is ON or OFF.

- : Effect off
- : Effect on







⑤ The built-in microphone's left-right channels status

If the built-in microphone's left-right channels status is different from the microphone's angle setting, the current left-right status is shown.

Icon	Mic angle	MIC setting
	Close (X-Y)	L-R
	Open (A-B)	R-L

2-Names and Functions of Parts

⑥ Power supply status

When a battery is being used, a battery icon shows the amount of power remaining in bars (, , , , ). The battery is almost dead and the power will soon turn off if the icon has no bars . When using the PS-P515U AC adaptor (sold separately) or USB bus power,  appears.

NOTE

Sometimes a "Battery Low" warning appears when recording or conducting other demanding operations even when battery power remains.

⑦ Recorder operation status

- Stopped
- || Paused
- ▶ Playing back
- ▶▶ Fast-forwarding
- ◀◀ Fast-rewinding
- ▶▶| Skipping forward
- |◀◀ Skipping backward

⑧ Level meter

The level of the input or playback sounds is shown.

When Monitor Mix is ON, the level of the combined input and playback sounds is shown.

⑨ File information

The file name or tag information of the file currently being played back is shown.

ID3 tag information is shown when available for an MP3 file being played.

NOTE

ID3 tag information includes the titles and artists names that can be saved in MP3 files.

⑩ Playback position display

The current playback position is shown by a bar. As playback progresses, the bar extends to the right.

⑪ Elapsed time

Shows the elapsed time (hours: minutes: seconds) of the currently playing track.

2-Names and Functions of Parts

⑫ Remaining time

Shows the remaining playback time of the current track (hours: minutes: seconds).

⑬ Peak value in decibels (dB)

The maximum level that occurs in a fixed period of time is displayed digitally.

⑭ Monitoring output

: Headphones

: Built-in speakers

⑮ Playback area

ALL All files in the MUSIC folder

FOLDER All files in the selected folder

P.LIST All files added to the playlist

⑯ Loop playback IN (starting) and OUT (ending) points

The set starting and ending points of the loop are shown.

The  icon appears at the playback position when the starting point is set.

The  icon appears at the playback position when the ending point is set.

⑰ Playback file number/total number of files

The total number of files in the playback area and the number of the current file are shown.

2-Names and Functions of Parts

Recording Screen

This screen appears when recording or in recording standby.

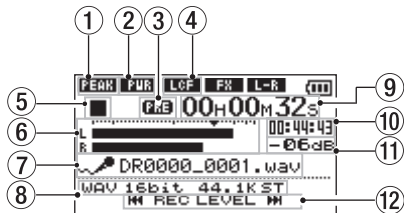

① Level control function status

OFF :Level control off

PEAR :Peak reduction on

AUTO :Automatic level control on

LAT :Limiter on

② Plug-in power status

PUR off

PUR on

③ Prerecording or Auto recording function status

PRE appears when the prerecording function is ON, and in recording standby.

A.REC appears when the auto recording function is ON, and recording.

④ Low cut filter status

LCF :Low cut filter off

LCF :Low cut filter on (when set to 40Hz, 80Hz, or 120Hz)

⑤ Recorder operation status

■ Recording standby

|| Recording paused (Recording standby)

● Recording

⑥ Recording level meters

The input signal level is shown.

During overdub recording, the level of the combined input and playback sounds is shown.

A ▼ mark is given at the -12dB position on the scale as a guide mark for input level adjustment.

⑦ File name

2-Names and Functions of Parts

The file name that will automatically be given to recorded files is shown.

⑧ **Recording mode**

Recording file format, sampling frequency, and stereo/mono (ST/MONO) status are shown.

⑨ **Elapsed recording time**

The elapsed recording time of the track appears as hours: minutes: seconds.

⑩ **Remaining recording time**

The remaining recording time until the selected max file size is reached appears in hours: minutes: seconds.

If the remaining recording time on the card is less than the remaining time until the selected max file size is reached, the remaining recording time on the card is displayed.

⑪ **Peak value in decibels (dB)**

Peak recording level values are shown digitally.

⑫ **Input level display button**

The **I◀◀** and **▶▶I** buttons are shown on the display to indicate that the input level can be changed using these buttons.

Press the button (**I◀◀** or **▶▶I**) to display the pull-up window that shows the input level at this position.

2-Names and Functions of Parts

Playback Control screen

The Playback Control screen is displayed if the **PB CONT** button is pressed during playback or when playback is stopped.

Recording cannot be performed while this screen is displayed. Press the **I◀◀** or **▶▶I** button to skip to the I/O point or the beginning/end, instead of the previous or next file.

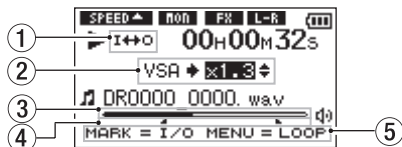

① Loop playback status

The **I◀◀** icon is displayed when loop playback is enabled.

② Playback speed

Playback speed as compared with the normal speed is shown.

VSA shown on the left to indicate that the VSA (variable speed audition: enables the

tempo to be changed without changing the pitch) function is enabled.

③ Playback position display

The current playback position is shown by a bar. As playback progresses, the bar extends to the right.

④ Loop playback IN (starting) and OUT (ending) points

The set starting and ending points of the loop are shown.

The **▲** icon appears at the playback position on the bar when the starting point is set.

The **■** icon appears at the playback position on the bar when the ending point is set.

⑤ Available buttons

The buttons available in the Playback Control screen are as follows.

MARK : Creates or deletes an IN or OUT point.

MENU : Switch over between ON and OFF status of the loop playback function.

NOTE

Unlike the other screens, the **QUICK** button in this screen works to display the quick menu containing only the **LEVEL ALIGN** function, and no other functions will be available.

2-Names and Functions of Parts

Menu item list

This list provides an overview of the various menu items.

Menu item	Function	Pages
REC SETTING	Recording mode settings	50
PLAY SETTING	Play area select, repeat setting, playback equalizer, jump-back settings	80, 88, 92, 93
BROWSE	microSD card file and folder operations	75
SPEAKER	ON/OFF status of built-in speaker	45
OTHERS	OTHERS submenu display	Right column

The OTHERS submenu appears when OTHERS is selected in the MENU screen. The menu items contained are as follows.

INFORMATION	Information about the file, microSD card, and system	107
MONITOR MIX	Monitor Mix settings	62
TUNER	Tuner settings	103
EFFECT	Effects settings	101
FILE NAME	File name settings	112
DATE/TIME	Date and time settings	42
SYSTEM	Various system settings	109

CAUTION

- When recording/in recording standby, the following screen and items are shown.
MIC POWER and LOW CUT on the REC SETTING screen
PB INPUT on the MONITOR MIX screen
All items on the EFFECT screen
- The **MENU** button is disabled in the Playback Control screen, but works to change over between ON and OFF status of the loop playback function. (See “Repeated Playback of Selection (Loop Playback)” on page 90.)

2-Names and Functions of Parts

Using menus

Use the MENU screen to make various settings.

Example: setting the playback area

- 1 Press the MENU button to open the MENU screen.

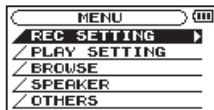

- 2 Use the + or - button to select a menu item (highlighted), and use the ► button to move to various settings screens.

Example: PLAY SETTING screen

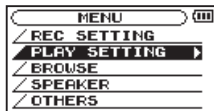

- 3 Use the + or - button to select a menu item (highlighted) to be set.

Example: AREA is selected.

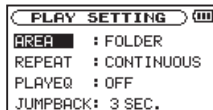

- 4 Use the ►► or ► button to move the cursor to highlight the value of the setting.

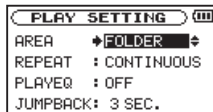

- 5 Use the + or - button to change the setting.
- 6 Press the ◀◀ button to set a different item in the same menu. This enables you to select a new item. Use the + or - button again to select an item to be set.
- 7 Repeat step 3 to 6 as necessary to set each item.
- 8 To open the MENU screen, press the MENU button. To return to the Home Screen (or OTHERS submenu screen), press the ◻ / ◻ (HOME) [■] button.

2–Names and Functions of Parts

Basic operation

Use the following buttons to operate the various screens.

MENU button:

Opens the MENU screen.

PB CONT button:

This opens the Playback Control screen.

⏪ / I (HOME) [■] button:

When any other screen is open, press this to return to the Home Screen. Use this to answer “NO” to a confirmation message.

▶ button:

Use this to confirm the selection of a setting item or to answer “YES” to a confirmation message.

▶▶ button:

Use this to move the cursor (the highlighted area) to the right on the screen, and to open folders on the BROWSE screen.

◀◀ button:

Use this to move the cursor (the highlighted area) to the left on the screen, and to close folders on the BROWSE screen.

+ button:

Use this to move the cursor (the highlighted area) upward on the screen, or increase values.

– button:

Use this to move the cursor (the highlighted area) downward on the screen, or decrease values.

QUICK button:

This opens the Quick menu.

A popup menu is turned on or off in the BROWSE screen or PLAYLIST screen.

3-Preparation

Powering the unit

DR-07MKII can operate on two AA batteries, or through an optional AC adapter (TASCAM PS-P515U) or USB cable provided with the unit (USB bus power).

Alkaline or Ni-MH batteries can be used.

Using AA batteries

Open the battery compartment cover on the back of the unit. Fit two AA batteries to the + and - marks shown in the compartment, and close the battery compartment cover.

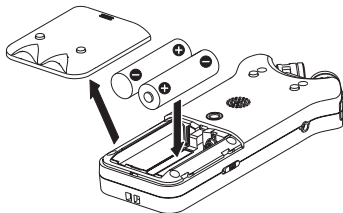

When using AA batteries, set the type of battery in order to accurately show the amount of power

38 TASCAM DR-07MKII

remaining and allow the unit to accurately determine whether power is available for proper operation. (See "Setting the type of AA batteries" on page 110.)

NOTE

- *Manganese dry cell batteries (R6) cannot be used with this unit.*
- *This unit cannot recharge Ni-MH batteries. Use a commercially available recharger.*
- *The included alkaline batteries are for confirming operation of the unit and might not last very long.*

Using an AC adaptor (sold separately)

Connect the PS- P515U AC adaptor and the USB cable to the USB port of the unit as shown in the illustration.

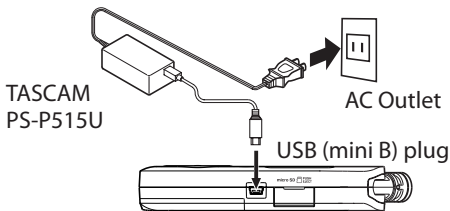

CAUTION

- *Never use any adaptor other than the designated PS-P515U AC adaptor. Use of a different adaptor could cause malfunction, fire or electric shock.*
- *Noise may occur when recording with a microphone if the unit is too close to the AC adaptor. In such a case, keep sufficient distance between the AC adaptor and the unit.*

NOTE

When both batteries are installed and the AC adaptor is connected, power will be supplied from the AC adaptor.

Using USB bus power

Connect the unit to a PC using the attached USB cable as shown in the illustration.

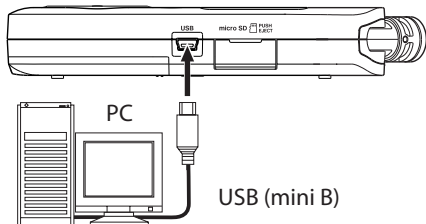

The USB SELECT screen appears to choose between USB bus power for power supply or connection with a PC through the USB cable when USB cable is connected after the unit is turned on or when the unit is turned on after connecting the USB cable. Use the + or - button to select BUS POWER and press the ► button to select power supply from the USB port. The Home Screen will appear.



NOTE

Power is supplied from the USB port if the USB cable is connected to the unit that contains batteries (USB bus power prioritized).

3-Preparation

Start-up & shutdown

CAUTION

- The unit goes in standby mode if shut down when the unit is operating on AC power supplied through the AC adapter (TASCAM PS-P515U, sold separately), or bus power supplied from a USB port of a PC.
- Turn down the volume of the sound system connected to the unit before starting up or shutting down the unit.
- Do not use headphones when starting up or shutting down the unit. Otherwise, a large noise would cause damage to headphones or your ears.

Starting up the unit

To start up the unit from the stopped state, press and hold the **⏻ / I (HOME) [■]** button until TASCAM DR-07MKII (start-up screen) is displayed on the display. The Home Screen appears when the unit starts up.



Start-Up Screen

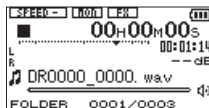

Home Screen

CAUTION

When the unit is started up for the first time (or when the built-in clock is reset after being left unused without batteries), the DATE/TIME screen appears before the start-up screen to adjust the date and time.



Press the **◀◀** or **▶▶** button to move the cursor (highlighted area), and use the **+/-** button to change values.

Press the ► button to fix the settings.

The start-up screen is displayed, and then the Home Screen appears after the unit has started up.

Date/time adjustment may be skipped by pressing the ► button, and made later. (See “Setting the date and time” on page 42)

Shutting down

Press and hold the ⏻ / | (HOME) [■] button until **LINEAR PCM RECORDER** appears on the display.

The power turns off after the unit completes its shutdown process.



CAUTION

Always use the ⏻ / | (HOME) [■] button to shutdown the unit.

Do not remove the batteries or disconnect the power cable (AC adapter TASCAM PS-P515U or USB cable) accidentally while the unit is operating. If you do so, the unit cannot shut down properly and all recordings, settings and other data will be lost. Lost data cannot be restored.

Resume function

The unit has resume function. When started up, the unit is located to the position (time) where it left off when shut down previously.

If the Playback button is pressed after start-up, the track the unit was playing when shut down previously starts to be played from the position (time) where the unit left off when shut down.

NOTE

The required data are stored in the microSD card. The resume function does not work if the card is exchanged or formatted.

3-Preparation

Setting the date and time

Using its internal clock, this unit remembers the date and time when a file is recorded.

- 1 Press the **MENU** button to open the **MENU** screen.

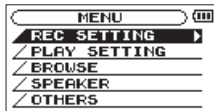

- 2 Use the + or - button to select the **OTHERS** menu item (highlighted), and press the ► button.

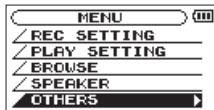

The **OTHERS** screen is displayed.



- 3 Use the + or - button to select the **DATE/TIME** menu item, and press the ► button.

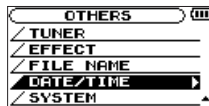

The **DATE/TIME** screen is displayed.



- 4 Press the ◀◀ or ▶▶ button to move the cursor (highlighted area), and use the + or - button to change values.
- 5 Press the ► button to confirm the change and return to the **OTHERS** screen.

NOTE

You can set the unit to automatically add the date to file names. (See "Setting the format of file names" on page 112.)

CAUTION

The date and time setting can only be maintained for a few minutes if the unit is not powered from batteries or through the AC adaptor TASCAM PS-P515U or the USB cable. When using batteries, replace them before they completely lose power.

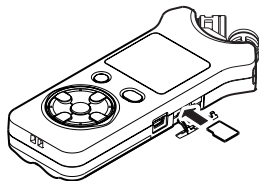

Inserting and removing microSD cards

Inserting the microSD card

NOTE

A microSD card is already installed when the unit is shipped from the factory. If you want to use this card to record and play tracks, there is no need to reinstall it.

- 1 Open the microSD slot cover on the right side panel.**
- 2 Insert the microSD Card into the slot as shown in the following illustration until it clicks into place.**

Removing the card

- 1 Open the microSD slot cover on the right side panel.**
- 2 Press the microSD card in gently and then release it to allow it to come out.**

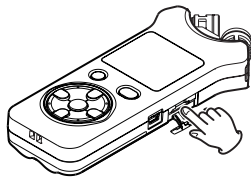

3-Preparation

CAUTION

- Do not remove the microSD card from the unit when it is connected to a computer by USB.
- microSD cards that meet microSD or microSDHC standards can be used with this unit.
- A list of microSD cards that have been confirmed to work with this unit can be found on our website (<http://tascam.com>).

Preparing a microSD card for use

In order to use a microSD card in this unit, you must format it first.

- 1 Confirm that a microSD card is installed and turn the power ON.**
- 2 The following message appears when a new card or a card formatted for use with another device is installed in the unit.**

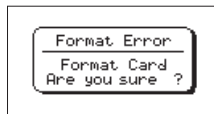

- 3 Press the ► button to start formatting.**
- 4 When formatting ends, the Home Screen opens.**

You can also reformat the card in this unit at any time. (See “System Settings and Formatting” on page 109.)

CAUTION

- When formatting a card, the unit should be operating on AC power supplied through the PS-P515U adapter (sold separately), USB bus power supplied from a computer, or batteries with sufficient remaining power.
- Formatting a card erases all the data on it.

Using the built-in speaker

Enable **SPEAKER** on the **MENU** screen to allow the unit to play over the built-in speaker.

- 1 Press the **MENU** button to open the **MENU** screen.
- 2 Use the **+** or **-** button to select the **SPEAKER** and press the **▶** button.

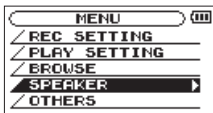

The **SPEAKER** screen is displayed.

- 3 Use the **+** or **-** button to select **ON**.



- 4 When finished, press the **⏻ / | (HOME) [■]** button to return to the Home Screen.

NOTE

Even if **SPEAKER** is enabled, the unit will not play through the speaker when the unit is recording sound, in recording standby, or muted with headphones or external speaker system connected.

3-Preparation

Connecting monitors and headphones

To listen with headphones, connect them to the Ω /LINE OUT jack.

To listen with an external monitoring system to the Ω /LINE OUT jack.

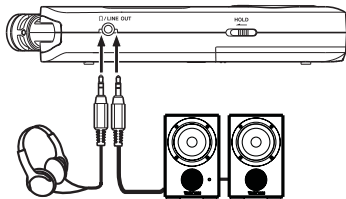

Headphones

Powered monitor speakers
or amplifier and speakers

Using the built-in microphone

This unit's built-in microphones can be adjusted, allowing the angles of the microphones to be changed. You can choose Clear Stereo Sound or Wide Stereo Sound according to the recording source, situation, etc. by opening or closing the microphone pair.

Setting the mics to record a wide stereo sound (A-B position)

Spread the stereo microphone to the left and right. (A-B position)

Set this way, the two microphones are spread widely left and right, and recording is possible with a strong stereo field that is good for music, for example.

If you open or close the microphone pair while using the built-in stereo microphone and the left-right channels does not suit the angle of the microphone, a pop-up message appears to ask whether you want to swap the left-right channels of the microphone. (See “Microphone position detection” on page 49.)



CAUTION

- Set the left-right channels of the built-in microphone to L-R. When you are using the built-in microphone and the setting is not L-R, **R-L** appears on the Home Screen. (See “Swapping the left-right channels of the built-in microphone pair” on page 48.)

Setting the mics to record a clear stereo sound (X-Y position)

Close the stereo microphone. (X-Y position)

Set this way, the microphone pair is close, and recording is possible with a clear stereo field with less phase difference.

If you open or close the microphone pair while using the built-in stereo microphone and the left-right channels does not suit the angle of the microphone, a pop-up message appears to ask whether you want to swap the left-right channels of the microphone. (See “Microphone position detection” on page 49.)

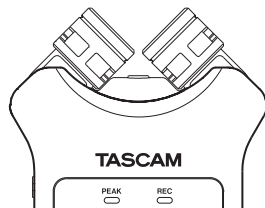

3-Preparation

CAUTION

- Set the left-right channels of the built-in microphone to R-L. When you are using the built-in microphone and the setting is not R-L, **L-R** appears on the Home Screen. (See “Swapping the left-right channels of the built-in microphone pair” below.)

Swapping the left-right channels of the built-in microphone pair

Depending on the angles at which the microphones are set, the recording channels of the left and right microphones can be swapped.

When the microphone pair is open, the left microphone should be set to the left channel and the right microphone should be set to the right channel (When A-B position, L-R). When the microphone pair is closed, the left microphone should be set to the right channel and the right microphone should be set to the left channel (When X-Y position, R-L).

If you are using the built-in microphone and this setting is not used, the current microphone setting icon appears as a warning on the Home Screen.

- 1 Press the **RECORD [●]** button to bring the unit in recording standby.

The REC indicator will flash and the recording screen will appear.

- 2 Press the **QUICK** button.

The Quick menu screen will appear.



- 3 Use the **+ or -** button to select (highlight) **MIC LR SWAP**, and press the **▶** button.

The MIC LR swap screen will appear.

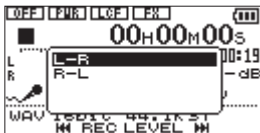

- 4 Use the + button or - button to select (highlight) L-R or R-L depending on the microphone pair's status.
- 5 Press the ► button to fix the setting, and to return to the Home Screen.

Microphone position detection

The following pop-up message appears automatically whenever the left microphone is opened or closed and the left-right channels does not suit the angle of the microphone. If only the right microphone is opened or closed, it does not appear.



Press the ► button to change the setting.
Press the ⏻ / | (HOME) [■] button to leave the setting as it is.

NOTE

- When you change the microphone angle setting and the pop-up message appears, you must press the ► button to change the L-R setting, press the ⏻ / | (HOME) [■] button to keep this setting as is, or restore the previous microphone angle to close the pop-up message before you can begin recording.
- The pop-up message does not appear if you change the microphone position when recording. If necessary, use the MIC LR SWAP setting by pressing the QUICK button to switch the setting after change the setting to recording standby mode by pressing the RECORD [●] button. (see the previous page).

4-Recording

In addition to using the built-in microphone, you can record using an external microphone or record the output signal from a mixer or other audio source. You can select among MP3 (44.1/48 kHz, 32–320 kbps) and WAV (44.1/48/96 kHz, 16/24-bit) audio recording formats.

As the unit is compatible with the BWF format for WAV files, marks added to the WAV files during recording are available when playing back the files using a BWF compliant software, etc.

With this unit, you can mix and record a sound input through the built-in mic or one of the input jacks with an audio file that is played back using the overdubbing function.

Selecting file format/sampling frequency/type, and maximum file size

Select the audio file type that you want to record before you start recording.

- 1 Press the **MENU** button to open the **MENU** Screen.
- 2 Use the **+** or **-** button to select **REC SETTING**,

and press the **▶** button.

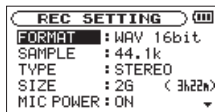

REC SETTING screen appears.

- 3 Use the **+** or **-** button to select **FORMAT**, and press the **▶▶** or **▶** button.

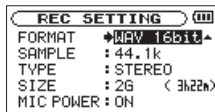

Set the file format with the + or - button to from the following:

WAV: 16bit (default), WAV 24bit
MP3: 32kbps, 64kbps, 96kbps, 128kbps,
192kbps, 256kbps, 320kbps

NOTE

- Higher values provide better recording quality.
- WAV files are higher quality than MP3 files, but they take up more space, so MP3 formats allow for longer recordings.

4 Press the \lll button to show settings.

5 Use the + or - button to select TYPE, and press the \ggg or \gg button.

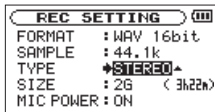

The procedure to select the creation of a stereo or mono file is as follows.

Use the + or - button to select STEREO (default) or MONO.

If MONO is selected, a mono file is created, and the same signals are sent to both L and R level meters and output channels.

If sound is recorded in MONO in WAV format, the file size will be half that recorded in STEREO, allowing long time recording.

6 Press the \lll button to show settings.

7 Use the + or - button to select SAMPLE, and press the \ggg or \gg button.

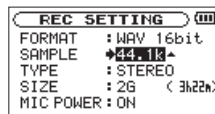

Set the sampling frequency with the + or - button to one of the following options.

44.1k (default), 48k, 96k

NOTE

96k cannot be selected if FORMAT is set to MP3.

8 Press the \lll button to show settings.

9 Use the + or - button to select SIZE, and press the \ggg or \gg button.

4-Recording

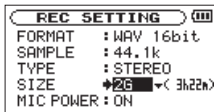

Set the maximum file size with the + or – button to one of the following options.

64M, 128M, 256M, 512M, 1G, 2G (default)

NOTE

- If the maximum set file size is exceeded during recording, the unit will automatically continue recording in a new file.
- Depending on the file format, the amount of recording time will differ for the same file size. The amount of recording time is shown on the right of the setting value (in parentheses).
- Recording automatically stops if recording time exceeds 24 hours.

10 Press the O / | (HOME) [■] button to return to the Home Screen.

Set where to save the file

Set the folder where recorded files are saved. The created sound file will be saved in the currently selected folder. For details, see “SELECT” pop up menu under “Folder operations” on page 78.

If no setting is made, new recording files are placed in the MUSIC folder.

Setting the input functions

- 1 Press the MENU button to open the MENU Screen.**
- 2 Use the + or – button to select REC SETTING, and press the ► button.**

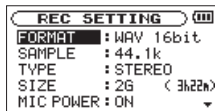

REC SETTING screen appears.

The following input settings are made in this screen. Use the ◀◀ or ▶▶ button or the + or – button to select the following settings.

MIC POWER:

When connecting a microphone that requires plug-in power, set this to **ON**. The factory default is **OFF**.

LOW CUT:

The factory default setting of the low cut filter is **OFF**, but you can also select **40Hz**, **80Hz** or **120Hz** as the cut-off frequency for a low cut filter.

CAUTION

- Set **MIC POWER** to **OFF** when using the built-in mic or connecting a dynamic microphone or microphone with a built-in battery. If set to **ON**, the plug-in power may damage such microphones.
- Use headphones to monitor when you are recording with a microphone. If you use speakers to monitor, the sound

output from the speakers may also be recorded, causing a poor recording and even feedback.

NOTE

MIC POWER and **LOW CUT** can be set when recording/in recording standby.

TIP

The LOW CUT filter can reduce noise such as offensive wind noise from air-conditioners and projectors.

Use the built-in effects of this unit as necessary on the input source. (See “Using the Effects” on page 101.)

4-Recording

Placing the unit and making connections

Recording with the built-in mics

Point the mics at the sound source and place the unit in a stable location where there is little vibration.

Recording with external mics (MIC IN)

Connect an external mic to the MIC/EXT IN connector.

Point the mics at the sound source and place the unit in a stable location where there is little vibration.

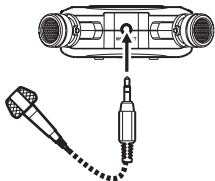

NOTE

- The setting of left-right channels is disabled if an external microphone is connected to the MIC/EXT IN jack.

Recording an external device (EXT IN)

Use a stereo miniplug cable to connect to the output of an external audio device.

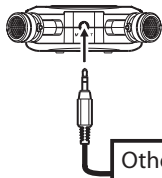

Other audio equipment
or external sound source

CAUTION

- Reduce the output level of the external audio device if the input sound is distorted even when reducing the input gain level on the unit.
- When an external audio device with a fixed output line level is connected, it would be impossible to control the gain level appropriately because of excessively large input signals. In such cases, use the headphone jack or other level-controllable output for connection to the unit.

NOTE

- The setting of left-right channels is disabled if an external microphone is connected to the MIC/EXT IN jack.

Adjusting the input level

Before starting recording, the input level should be adjusted to prevent the recorded sounds from being distorted due to excessively large input signals or from being inaudible due to excessively low input signals compared to noise.

In addition to manual adjustment, the unit has the following three level adjustment functions: peak reduction, automatic level control, and limiter. Any of these can be used as required.

TIP

In addition to adjusting the INPUT level, try changing the distance and angle between the microphone and the sound source. The angle and distance of the microphone can also change the character of the recorded sound.

Manually adjusting the input level

The following procedures explain how to use the Record Screen to set the levels.

CAUTION

Manual adjustment cannot be performed when the automatic level control mode is selected as a level control function (**AUTO** lighted on the upper left in the recording screen). To enable manual input level adjustment, select OFF or other mode in the level control setting screen (see "Using the Level Control Function" on page 57).

1 Press the RECORD [●] button to begin recording standby.

The record indicator flashes red and the recording screen appears.



2 The ◀◀ or ▶▶ button is used to adjust

4-Recording

the input level. Press the **◀◀** or **▶▶** button to show a pull-up menu screen for input level setting.

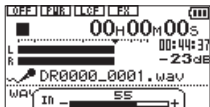

If the input is too high, the **PEAK** indicator on the upper left above the display lights.

A ▼ mark is provided at -12dB on the level meters. Set the input level so that the indicator bars move to and fro with this mark at about the center without causing the PEAK indicator to light red when the loudest sounds occur.

NOTE

- Press the **⏻ / | (HOME) [■]** button to exit recording standby.
- When in recording standby or during recording, the speaker does not output sound even if the **SPEAKER** setting is enabled. Connect headphones to the **LINE OUT** jack if you want to adjust the level or record while monitoring the input. Use the **+** or **-** button in the Home Screen to adjust the monitoring volume. This does not affect the sound to be recorded.

Using the Level Control Function

The level control function for recording through a microphone is set as follows.

1 Press the RECORD [●] button to bring the unit in recording standby. The REC indicator will flash and the recording screen will appear.

2 Press the QUICK button.

The Quick menu screen will appear.

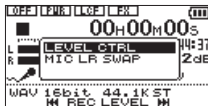

3 Use the + or – button to select (highlight) LEVEL CTRL, and press the ► button.

The level control setting screen will appear.

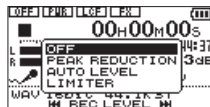

Options: OFF(default), PEAK REDUCTION, AUTO LEVEL, LIMITER

4 Use the + or – button to select (highlight) a mode, and press the ► button to enable the mode and return to the recording screen.

The selected mode is shown with an icon in the recording screen.

PEAK REDUCTION:

The input volume is reduced automatically to an appropriate level when excessively large signals

4-Recording

come in. This allows recording level setting to be performed easily.

The recording level can be raised manually if required.

TIP

When recording live performances, for example, test for peak reduction may be performed before actual recording.

Select the peak reduction mode in recording standby, and maximize the recording level.

As a test performance is given subsequently, the input gain for recording is reduced to an appropriate level to meet the input signals, and an optimum recording level for the performance is set.

Recording will be stored at this recording level if this mode is disabled before starting recording.

Otherwise, the recording level will continue to be controlled automatically during recording.

It is also possible to store the recording in the limiter mode after automatically setting the recording level in the peak reduction mode.

AUTO LEVEL:

The recording level is controlled automatically to increase or decrease the input level when the input signals are too small or too large, respectively. This mode is useful for recording at meetings. In this mode, the recording level cannot be changed manually.

LIMITER:

This prevents distortion of sounds when excessively large input signals come in suddenly.

This mode is also suited for recording of live performances with large volume changes.

In this mode, the recording level can be changed manually during recording.

CAUTION

Distortion of sounds may occur when excessively large input signals come in even if the LIMITER function is activated. In such a case, lower the recording level or keep proper distance between the unit and the source.

Recording

Before starting the following operation procedures, level adjustment should be completed, and the Home Screen should be open.

- 1 Press RECORD [●] button to begin recording standby.

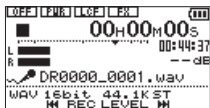

The screen shows the recording file name, the input source, the recording audio file type and sampling frequency. Please confirm that these are as desired before starting recording.

NOTE

If you have set the MONITOR Screen's INPUT item to ON so that you can always monitor the input, a pop-up appears that allows you to turn overdubbing ON or OFF.

For ordinary recording, select OFF and continue to step 2.

- 2 To start recording, press the RECORD [●] button again.

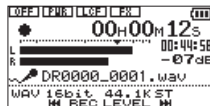

When recording starts, the REC indicator lights continuously, and the display shows the elapsed recording time and the remaining recording time.

- 3 Press the ⏻ / | (HOME) [■] button to end recording and create the audio file.

To pause recording, press the RECORD [●] button. Press the RECORD [●] button again to restart recording in the same track. If you press the ⏻ / | (HOME) [■] button after pausing a recorded audio file up to the moment that you paused recording is created.

4-Recording

NOTE

To avoid accidental recording of the noise from pressing the **RECORD** [●] button, the start of recording is delayed by 0.3 second (fixed) after the **RECORD** [●] button is pressed. (REC DELAY)

CAUTION

Noise may occur when recording with a microphone if the unit is too close to the AC adaptor. In such a case, keep sufficient distance between the AC adaptor and the unit.

Recording playback and input sounds together (overdubbing)

By overdubbing, you can play an instrument or sing as you play back a saved track and mix and record both sounds in a new file.

NOTE

- You cannot overdub if input monitoring is OFF.
- The prerecording function is disabled if the input monitor is ON for overdubbing.

- Overdub recording is not possible when using the AUTO REC function.
- When overdub recording, you cannot start new files manually.
- You cannot pause during overdub recording. (You cannot use the RECORD [●] button.)
- The sampling frequency of the playback file is preserved regardless of the sampling frequency setting for overdub recording.
- You cannot make an mp3 file when overdubbing a WAV file with a sampling frequency of 96kHz.

Select the file you want to overdub

- 1 Use the **◀◀** and **▶▶** buttons and the **BROWSE** screen to select that files that you want to overdub.

NOTE

See "Working with Files and Folders (BROWSE Screen)" on page 75 for selecting files using the BROWSE screen.

Selecting file format

- 1 Press the **MENU** button to open the **MENU** screen.
- 2 Use the **+** or **-** button to select **REC SETTING**, and press the **▶** button.

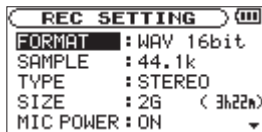

REC SETTING screen appears.

- 3 Use the **+** or **-** button to select **FORMAT**, and press the **▶▶** or **▶** button.

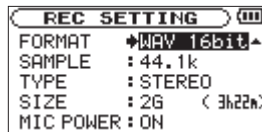

- 4 Set the file format with the **+** or **-** button.
- 5 Press the **⏻** / **| (HOME)** [**■**] button to return to the Home Screen.

4-Recording

Simultaneous listening to playback and input sound (Monitor Mix)

This allows you to listen to playback and input sound at the same time (Monitor Mix).

NOTE

The prerecording function is disabled if the "MONITOR MIX" is "ON".

- 1 Press the **MENU** button to open the **MENU** screen.
- 2 Use the **+** or **-** button to select **OTHERS**, and press the **▶** button to open the **OTHERS** submenu.
- 3 Use the **+** or **-** button to select **MONITOR MIX**, and press the **▶** button.

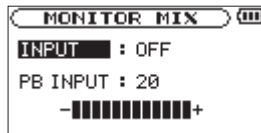

MONITOR MIX screen appears.

- 4 Use the **+** or **-** button to select **INPUT**, and press the **▶▶|** or **▶** button.
- 5 Use the **+** or **-** button to select **ON**.

(Default: OFF)

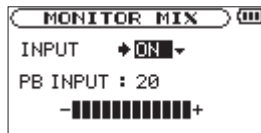

Monitoring of input sound is now enabled.

- 6 Press the **◀◀|** button to highlight the item.

- 7 Use the + or – button to select PB INPUT, and press the ►►| or ► button.



- 8 Use the + or - button to adjust the playback volume level in a range from 0 to 20.

- 9 When finished, press the ⏻ / | (HOME) [■] button to return to the Home Screen.

TIP

By making the above settings, in addition to overdubbing, you can use a recorded (or copied) audio track for instrument practice or karaoke.

NOTE

You cannot select ON or OFF for INPUT items on the MONITOR MIX during recording/in recording standby.

Adjusting the input level (simple adjustment)

If Monitor Mix is enabled (INPUT is selected in the MONITOR MIX screen), the input level can be adjusted in a simple way in the Quick menu screen.

NOTE

The level meters are designed to be hidden from the Quick menu screen, so you cannot use them when you make adjustments.

- 1 Press the QUICK button while the Home screen is open during playback or when stopped.

The Quick menu screen appears.



Quick menu screen when stopped

4-Recording

- While listening to the input sound, use the **◀◀** or **▶▶** button to adjust the input level. When the **◀◀** or **▶▶** button is pressed, a pull-up window showing input level settings appears in the display.



NOTE

When input monitoring is ON and during overdub recording, the **PEAK** indicator lights when the combined input and playback signals become higher than the set level.

CAUTION

- If the Monitor Mix function is disabled, the pull-up window will not appear when pressing the **◀◀** or **▶▶** button.
- When distortion of sound is about to occur as the input sound level is increased, the **PEAK** indicator on the upper left above the display will be turned on. Adjust the input level for recording so as not to allow the **PEAK** indicator to be turned on.

Start the overdubbing

- 1 Press the RECORD [●] button to set the unit to record standby.

The overdubbing ON/OFF pop-up appears.

The recording file name, input source, recording audio file type and sampling frequency also appear so that you can confirm them before you start recording.

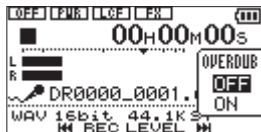

- 2 Use the + or - button to select ON from the overdubbing ON/OFF pop-up.



- 3 Press the RECORD [●] button to start overdubbing.

When recording starts, the REC indicator lights and the display shows the elapsed and remaining recording times.

The following error message appears if the selected file cannot be played back.

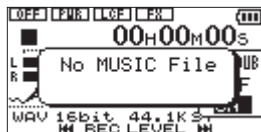

- 4 To stop recording, press the ⏻ / | (HOME) [■] button.

4-Recording

Recording automatically (AUTO REC)

The unit starts and pauses recording, renews files, and sets marks automatically depending on the input signal level.

This function allows the unit to respond to input sound levels and start and pause recording, as well as set marks and create new files, for example.

- 1 Press **MENU** to open the Menu Screen.
- 2 Use the **+ or -** button to select **REC SETTING**, and press the **▶** button.

REC SETTING screen appears.

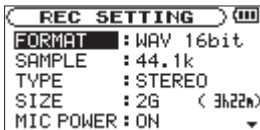

- 3 Use the **+ or -** button to select the **MODE** and

press the **▶▶|** button or **▶** button.

- 4 Use the **+ or -** button to set the "AUTO REC" setting.



OFF(Default): Off

REC: Records and pauses automatically

MARK: Sets marks automatically during recording

- 5 Press the **◀◀|** button to select the other item.
- 6 Use the **+ or -** button to select **LEVEL** and press the **▶▶|** button or **▶** button.



- 7 Use the + or - button to select the level that signal is judged to have been input when it exceeds this level.

Set the value to one of the following selection.

-6dB/-12dB (default)/-24dB/-48dB

- 8 Press the O/I (HOME) [■] button to return to the Home Screen.
- 9 Press the RECORD [●] button to put the unit into recording standby.

Recording starts automatically when the input signal exceeds the LEVEL.

- 10 The recording mode changes according to the setting of the MODE.

REC:

If the input signal level falls below the standard level for more than five seconds, which is set on LEVEL, the unit goes into in recording standby. When the input signal level becomes higher than the standard level, the unit restarts recording on a new file.

MARK:

If the input signal level falls below the standard level for more than five seconds, which is set on LEVEL, the unit adds marks when the input signal level becomes higher than the standard level again.

- 11 Press the O/I (HOME) [■] button to stop automatic recording.

4-Recording

TIP

By using this in combination with the **PRE REC** function, you can record events without losing the beginnings of sounds.

CAUTION

- *Overdub recording is not possible when using the **AUTO REC** function.*
- *Self-timer function is not possible when using the **AUTO REC** function.*

Creating and changeover to a new file during continued recording (Track incrementing)

You can manually or automatically split a recording by creating a new file. (Track incrementing)

Manual track incrementation during recording

You can manually split a recording by creating a new file.

1 Press the **QUICK** button while recording.

NOTE

When new files are created, incremental numbers are added to the end of each file name.

CAUTION

- *A new file cannot be created if the total number of files and folders would exceed 5000.*

- Files shorter than two seconds cannot be created.
- If the name of a newly created file would be the same as that of an existing file, the number will be incremented until the new file has a unique name.
- Track incrementing is not possible when overdub recording.

Automatic track incrementation by file size

Without pausing recording, a new file can be created automatically during recording when a file size set in advance is exceeded.

1 Press the MENU button to open the MENU Screen.

2 Use the + or – button to select REC SETTING, and press the ► button.

REC SETTING screen appears.

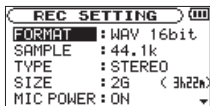

3 Use the + or – button to select SIZE, and press the ►► or ► button.

Use the + or – button to set the maximum file size at which track incrementing takes place, by selecting (highlighting) from the following:

64M/128M/256M/512 M/1G/2G (default)

4 Press the ⏪ / | (HOME) [■] button to return to the Home Screen.

CAUTION

A new file cannot be created if the total number of files and folders would exceed 5000.

NOTE

For the same file size, the possible recording time differs depending on the file type selected. Furthermore, if the recording time is 24 hours or more, this will be displayed as 23:59:59.

4-Recording

Mark function

Adding marks manually to a recording

You can manually add marks to a recording where you want them.

Press the MARK button while recording to add a mark.

Mark number pull-up appears.

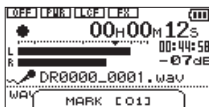

NOTE

- Mark information is stored in the file with numbers between 01–99. The maximum number of marks in a file is 99.
- As the unit is compatible with the BWF format for WAV files, marks added to a WAV file during recording are stored in the file. Marks stored in the file are available when playing back the file using a BWF compliant software, etc.

Adding marks automatically to a recording

This function allows the unit to add marks automatically using AUTO REC.

Set the MODE to MARK on the AUTO REC screen.



See "Recording automatically (AUTO REC)" on page 66.

Moving to a mark position

You can move to marks in the currently selected file when paused and during playback.

You can use this function to identify points to create shortcuts to the beginning of songs, for example.

Press the ◀◀ or ▶▶ button while pressing and holding the MARK button during playback or when stopped.

NOTE

You cannot move to a mark in a different file.

4-Recording

Recording the moment before pushing RECORD (PRE REC)

By using prerecording, when the unit is in recording standby you can record up to two seconds of the signal input before the **RECORD** [●] button is pushed to start recording.

- 1 Press the **MENU** button to open the **MENU** screen.
- 2 Use the **+** or **-** button to select **REC SETTING**, and press the **▶** button.
- 3 Use the **+** or **-** button to select **PRE REC**, and press the **▶▶** or **▶** button.
- 4 Use the **+** or **-** button to select **ON**.

(Default: OFF)

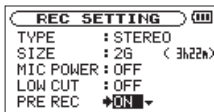

- 5 Press the **⏪ / | (HOME) [■]** button to return to the Home Screen.

TIP

By using this in combination with the **AUTO REC** function, you can record events without losing the beginnings of sounds.

NOTE

- If the amount of time in record standby is less than two seconds, the sound for that amount of time is recorded.
- You cannot use the **PRE REC** function with overdub recording. The prerecording function is disabled when you record using overdubbing.

Self-timer function

Like a camera, the unit has a self-timer to trigger the start of recording after a set period of time.

- 1 Press **RECORD [●] button when stopped or playing back to set the unit in recording standby, and press the PB CONT button.**
- 2 **The self-timer icon  appears in the recorder status screen, and time is shown on the right.**

Each time you press the PB CONT button, the setting changes as follows:

OFF (default) → 5S (5 seconds) → 10S (10 seconds) → OFF

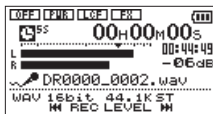

RECORD[●] or ► button.

Recording will start after the set time period.

NOTE

- *This function cannot be used when recording is paused in the middle of recording.*
- *Self-timer function is not possible when using the AUTO REC function.*

- 3 **Set the time period, and press the**

4-Recording

Recording duration

The table below shows the maximum recording time on microSD/microSDHC cards of different capacities for different file formats for recording.

File format (recording setting)			microSD/microSDHC card capacity (hours:minutes)			
			1 GB	2 GB	4 GB	8 GB
WAV (stereo)	16 bit	44.1 kHz	1:41	3:22	6:44	13:28
		48 kHz	1:33	3:06	6:12	12:24
		96 kHz	0:46	1:33	3:06	6:12
	24 bit	44.1 kHz	1:07	2:15	4:30	9:00
		48 kHz	1:02	2:04	4:08	8:16
		96 kHz	0:31	1:02	2:04	4:08
MP3 (stereo/ mono)	32 kbps	44.1 kHz/48 kHz	74:32	149:04	298:08	596:16
	64 kbps	44.1 kHz/48 kHz	37:16	72:32	149:04	298:08
	96 kbps	44.1 kHz/48 kHz	24:50	49:40	99:20	198:40
	128 kbps	44.1 kHz/48 kHz	18:38	37:16	74:32	149:04
	192 kbps	44.1 kHz/48 kHz	12:25	24:50	49:40	99:20
	256 kbps	44.1 kHz/48 kHz	9:19	18:37	37:16	74:32
	320 kbps	44.1 kHz/48 kHz	7:27	14:54	29:48	59:36

- The recording times shown above are estimates. They might differ depending on the microSD/microSDHC card in use.
- The recording times shown above are not continuous recording times, but rather they are the total possible recording times for the microSD/microSDHC card.
- If recorded in mono in WAV files, the maximum recording time will be double the figures above.

5–Working with Files and Folders (BROWSE screen)

On the **BROWSE** Screen, you can view the contents of the Music Folder, which contains the audio files on the microSD card that you can use with the DR-07MKII. On this screen, you can also play and erase selected audio files, create folders, add tracks to the playlist and so on. (See “Playlist” on page 84.)

TIP

*If you connect the DR-07MKII with a computer by USB, or mount the microSD card on a computer using a card reader or other input, you can change the folder structure within the **MUSIC** Folder and erase files from the computer as you would the contents of a hard drive. Furthermore, you can change file names from the computer.*

To open the **BROWSE** Screen, press the **MENU** button to open the **MENU** screen. Use the + or – button to select **BROWSE** and press the ► button.

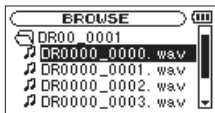

The contents of the folder that contains the file that was selected on the Home Screen before the **BROWSE** Screen was opened appears on the display.

Screen navigation

On the **BROWSE** Screen, folders and music files appear in a hierarchical structure much like they would appear on a computer. On the DR-07MKII, folders can only be used to two levels.

- Use the + or – button to select files and folders.
- When a folder is selected, press the ►► button to show the contents of that folder.
- When a file or folder is selected, press the ◀◀ button to exit the currently open folder and go to a higher level in the folder structure.
- When a file or folder is selected, press the **QUICK** button to open the pop-up window.
- When a file is selected, press the ► button to return to the Home Screen and play the file.

5-Working with Files and Folders

This folder that contains this file becomes the current folder, and new recorded file will be saved in this folder. If the playback area has been set to FOLDER, this folder becomes the new playback area.

- When a folder is selected, press the ► button to return to the Home Screen. The first file in the folder (shown at the top of the file list) will be played.

This folder becomes the current folder, and new recorded files will be saved in this folder. Regardless of the previous setting, the playback area is set to FOLDER, and this folder becomes the new playback area.

Icons on the BROWSE screen

The meanings of icons that appear on the BROWSE Screen are as follows.

Root Music Folder (MUSIC)

The MUSIC Folder is the highest (root) level folder in the hierarchy shown on the BROWSE Screen.

Audio file

This icon appears before the names of music files.

Plus folder

This icon shows folders that contain subfolders.

Plain folder

This icon shows folders that do not contain subfolders.

Open folder

The contents of the folder marked with this icon currently appear on this screen.

5-Working with Files and Folders

File operations

Select the desired audio file on the **BROWSE** Screen and press the **QUICK** button to open the pop-up window that is shown below.

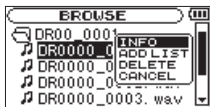

Use the + or – button to select the item you want from the following list and press ► button to execute it.

INFO

Information (date/time, size) about the selected file appears. Press the ► button again or press the ⏪ / I (**HOME**) [■] button to return to the **BROWSE** screen.

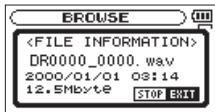

ADD LIST

Adds the selected file to the playlist. (See "Playlist" on page 84.)

DELETE

A message appears to confirm that you want to delete the file. Press the ► button to erase the file and the ⏪ / I (**HOME**) [■] button to cancel the deletion operation.



CANCEL

The operation for the selected (highlighted) file is canceled, and the pop-up menu is closed.

NOTE

*The pop-up menu can also be closed by pressing the **QUICK** button.*

5-Working with Files and Folders

Folder operations

Select the desired folder on the **BROWSE** Screen and press the **QUICK** button to open the pop-up window that is shown below.

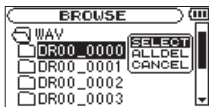

Use the + or – button to select the item you want from the following list and press the ► button to execute it.

SELECT

Returns to the Home Screen and selects the first file in the folder. Regardless of the previous setting, the playback area is set to **FOLDER**, and this folder becomes the new playback area. When recording, files are created in this folder.

ALL DEL

A pop-up message appears to confirm that you want to delete all the files in the selected folder at once.

Press the ► button to erase the files or press the ⏪ / | (**HOME**) [■] button to cancel.



NOTE

You cannot erase read-only files and files that are not recognized by this unit.

CANCEL

The operation for the selected (highlighted) file is canceled, and the pop-up menu is closed.

NOTE

*The pop-up menu can also be closed by pressing the **QUICK** button.*

5-Working with Files and Folders

Creating a new folder

In the file list, **NEW FOLDER** appears at the bottom.



Select (highlight) **NEW FOLDER**, and press the ► button. A pop-up appears to confirm that you want to create a new folder.



Press the ► button to create a new folder or press the ⏪/| (**HOME**) [■] button to cancel.

Note that the unit supports only a two-level folder structure, and accordingly **NEW FOLDER** does not exist in the second-level folders.

A newly created folder becomes the current one, and new recorded files are saved in this folder. If the playback area has been set to **FOLDER**, this folder becomes the playback area.

6-Playback

On the Home Screen, you can use the **I◀◀** and **▶▶I** buttons to select the playback track. The files that you can select are determined by the playback area setting.

Limiting the playback area makes track selection easier when you have numerous recorded and copied tracks on the microSD card.

On the **PLAY SETTING** Screen, you can select all files, the current folder or the playlist as the playback area. You can also use the **BROWSE** Screen to set a folder as the playback area.

TIP

*On the **BROWSE** Screen, regardless of the playback area setting, you can select any file on the card that you want.*

Adjusting playback volume

The volume of output through the built-in speaker or the **Ω/LINE OUT** connector can be adjusted using the **+** or **-** button while the Home Screen is shown.

A pull-up volume indicator appears.

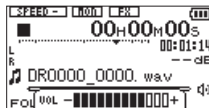

Setting the playback area (AREA)

Set the playback area for repeat and ordinary playback on the **PLAY SETTING** screen.

- 1 Press the MENU button to open the MENU Screen.**
- 2 Use the + or - button to select PLAY SETTING and press the ▶ button.**

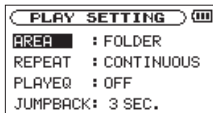

- 3 Use the + or – button to select (highlight) AREA, and press the ►► or ► button.

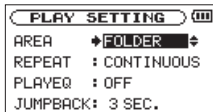

- 4 Use the + or – button to set the playback area.

ALL FILES

Set the playback area as all files in the Music Folder on the microSD card.

FOLDER (default)

Set the playback area as all the files in the currently selected folder.

PLAYLIST

Set the playback area as the tracks in the playlist. (See “Playlist” on page 84.)

If there is no playlist defined, a No PLAYLIST pop-up appears.



- 5 Press the \odot / | (HOME) [■] button to return to the Home Screen.

NOTE

The current playback area setting appears in the lower left of the Home Screen.

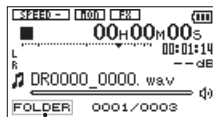

Playback area indication

6-Playback

Selecting a folder for the playback area (1)

Regardless of the current playback area, if you select a folder on the BROWSE Screen, the playback area changes to the selected folder.

- 1 Press the **MENU** button to open the **MENU** screen.
- 2 Use the **+** or **-** button to select **BROWSE**, and press the **▶** button.

BROWSE screen appears.

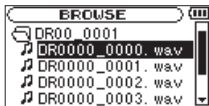

A file list of the folder that contains the file selected in the Home Screen is displayed.

- 3 Use the **◀◀** or **▶▶** button to select a folder level, and use the **+** or **-** button to select a folder.

For an explanation of how to use the Browse Screen, see "Screen navigation" on page 75.

- 4 Press the **QUICK** button to open the following pop-up window.

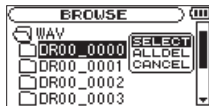

- 5 Use the **+** or **-** button to select **SELECT**, and press the **▶** button.

The display returns to the Home Screen. The first file in the folder is selected, and the unit is stopped.

Regardless of the previous setting, the playback area is set to **FOLDER**, and this folder becomes the playback area. This folder becomes the current folder, and new recorded files will be saved in this folder.

Selecting a folder for the playback area (2)

When the playback area is set to FOLDER, if you select a file on the BROWSE Screen, the folder that contains the selected file becomes the playback area.

- 1 Press the MENU button to open the MENU screen.
- 2 Use the + or – button to select BROWSE, and press the ► button.

BROWSE screen appears.

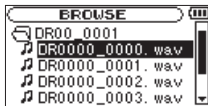

A file list of the folder that contains the file selected in the Home Screen is displayed.

- 3 Use the ◀◀ or ▶▶ button to select a folder level, and use the + or – button to

select the folder that contains the track (file) you want to play.

For an explanation of how to use the BROWSE Screen, see “Screen navigation” on page 75.

- 4 Press the ►▶ button.
- 5 Use the + or – button to select the desired file.

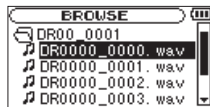

- 6 Press the ► button.

The display returns to the Home Screen, and the selected track starts playing.

This folder becomes the current folder, and new recorded files will be saved in this folder. In addition, the folder that contains this track becomes the playback area regardless of the playback area folder set previously.

6-Playback

Playlist

You can make a list of tracks for playback (playlist). On the Play Mode Screen if you select **PLAYLIST** for the **AREA** item, you can set playback to just the tracks in your playlist.

Adding tracks to the playlist

- 1 Press the **MENU** button to open the **MENU** screen.
- 2 Use the **+ or -** button to select **BROWSE**, and press the **▶** button.

BROWSE screen appears.

NOTE

For an explanation of how to use the **BROWSE** Screen, see “Screen navigation” on page 75.

- 3 Use the **+ or -** button to select the file you want to add to the playlist, and press the **QUICK** button.

NOTE

For details about how to select the file, see “Screen navigation” on page 75.

A pop-up window appears.

- 4 Use the **+ or -** button to select **ADD LIST**.

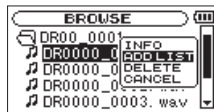

- 5 Press the **▶** button.

The track is added to the playlist and the popup window closes.

- 6 Repeat steps 3, 4, and 5 as necessary to add more tracks to the playlist. The tracks are numbered in the order that they are added.

Editing the playlist

You can view and edit the playlist you have made on the PLAYLIST screen.

You can also use this screen to play tracks and to edit the playlist.

- 1 Press the **MENU** button to open the **MENU** screen.
- 2 Use the **+** or **-** button to select **BROWSE**, and press the **▶** button.

BROWSE screen appears.

- 3 Use the **◀◀** button to move to the top folder level.



- 4 Use the **+** or **-** button to select **PLAYLIST**, and press the **▶▶** button.

PLAYLIST screen appears.



- 5 Use the **+** or **-** button to select the file you want to edit, and press the **QUICK** button.

A pop-up window appears.



- 6 Use the **+** or **-** button to select an item, and press the **▶** button to cause the unit to work as follows.

ALL CLR

A confirmation message appears to confirm that you want to remove all the files from the playlist.

6-Playback

Press the ► button to remove all the files or the ⏪ / I (HOME) [■] button to cancel this operation.

For this operation, it does not matter which track you select in step 5. All the files are removed from the playlist, but they are not erased from the microSD card.



DELETE

Remove the selected track from the playlist.

The file is removed from the playlist, but it is not erased from the microSD card.

MOVE

Select this to change the order of tracks in the playlist.

In addition to the file name, the track number also appears highlighted in inverse.

- Use the + or – button to move the selected track to a different position in the playlist.



In the above example, the 4th track has been moved to the 3rd track position.

- Press the ► button.
The display returns to the PLAYLIST screen.

CANCEL

The operation for the selected file is canceled.

Selecting files for playback (skip)

When the Home Screen is open, press the **◀◀** and **▶▶** buttons to select the file for playback. If you press the **◀◀** button when the playback position is located at the middle of a file, it will return to the beginning of that file. If you press the **◀◀** button when located at the beginning of a file, the playback position will skip to the beginning of the previous file.

If you press the **▶▶** button when located at the beginning of or middle of a file, the playback position will skip to the beginning of the next file.

NOTE

- Only files in the playback area that is currently set can be selected for playback.
- The track name, file number and other file information for the currently playing track appear on the display.
- The **■** icon appears on the display when playback is stopped at the beginning a track, and the **■** icon appears when playback is stopped in the middle of a track (paused).
- When the IN and OUT points are set in the file, pressing the **◀◀** or **▶▶** button skips to those points. Press the button repeatedly until the file you want is selected.

Playback

When the Home Screen is open and playback is stopped, press the **▶** button to start playback.

NOTE

- Files in the playback area can be played.
- You can also choose files for playback by name on the BROWSE screen.

Pausing

When the Home Screen is open and a track is playing back, press the **⏻ / | (HOME) [■]** button to pause playback at the current position. (PAUSE)

Press the **▶** button again to restart playback from that position.

Stopping

When the Home Screen is open and a track is playing back, press the **⏻ / | (HOME) [■]** button to pause playback, and press the **⏻ / | (HOME) [■]** button to return to the beginning of the file. (STOP)

6-Playback

Rewinding and fast-forwarding (search)

When the Home Screen is open and a track is playing back or stopped, press and hold the **◀◀** or **▶▶** button to rewind or fast-forward and search the playback track.

NOTE

Press and hold the **◀◀** or **▶▶** button to accelerate the search speed.

Repeat playback (REPEAT)

You can repeatedly playback one file or multiple files within a designated area.

- 1 Press the **MENU** button to open the **MENU** screen.
- 2 Use the **+** or **-** button to select **PLAY SETTING**, and press the **▶** button.
PLAY SETTING screen appears.
- 3 Use the **+** or **-** button to select **REPEAT**, and press the **▶▶** or **▶** button.

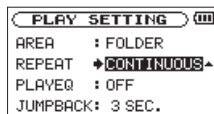

- 4 Use the **+** or **-** button to select a repeat mode.

CONTINUOUS (default):

All tracks in the playback area are played in sequence one time. (This setting is the ordinary playback mode.)

SINGLE:

The selected track is played once without repeating. The **SINGLE** icon appears on the Home Screen.

1 REPEAT:

The current track is played repeatedly. The **1** icon appears on the Home Screen.

ALL REPEAT:

All tracks in the selected playback area are played back repeatedly. The **ALL** icon appears on the Home Screen.

NOTE

If you start loop playback, the REPEAT item automatically switches to OFF if it is in a different mode.

5 Press the \odot / | (HOME) [■] button to return to the Home Screen.

Special Playback Control Functions

The unit has some special playback control functions. For example, you can playback a selected section of a track repeatedly or change the tempo of music without changing the pitch. You can also enhance the perceived overall sound pressure for comfortable listening when the playback is indiscernible.

These playback control functions serve for effective practice on musical instruments and analysis of musical passages.

Playback Control Screen

Use the Playback Control screen to set the playback control functions.

While the Home Screen is open when stopped or playing back, press the **PB CONT** button to open the Playback Control screen.

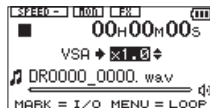

This screen can be used to make settings for the playback speed and loop playback.

After you finish making settings on this screen, press the \odot / | (HOME) [■] button (or press the **PB CONT** button) to return to the Home Screen.

6-Playback

Repeated Playback of Selection (Loop Playback)

With this function, you can continuously repeat (loop) the playback of a selection that you make.

- 1 While the Home Screen is open when stopped or playing back, press the PB CONT button to open the Playback Control screen.

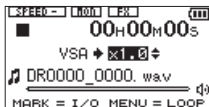

- 2 Press the ► button to start playback, and press the MARK button at the start point of the section that you want to play repeatedly. This position is set as IN (start) point. Then, ▴ appears at the corresponding point under the playback indicator bar.

- 3 Press the MARK button at the end point of the section that you want to play repeatedly. This position is set as OUT (end) point, and loop playback of the section between the IN and OUT points starts.

Then, ▾ appears at the corresponding point under the playback indicator bar.

During loop playback the I↔O indicator also appears.

Press the PB CONT button to return to the Home Screen while maintaining the I/O and loop settings effective. Even after returning to the Home Screen, the I↔O icon continue to be shown, along with the ▴ and ▾ marks shown at the points corresponding to the IN and OUT points under the playback indicator bar.

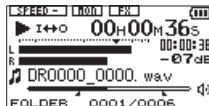

NOTE

- The pop-up message of “I/O Too Short” appears if the section between the IN and OUT points is too short. Set them again. The section should be 1 second or longer.
- Press the **MARK** button again to clear the IN and OUT points.
- To stop loop playback, press the MENU button when the Playback Control screen is open. Press the **MENU** button again to start loop playback between the set IN and OUT points.
- You cannot set the IN and OUT points in different files.
- The previous IN and OUT point settings are lost when you set the IN point on a different file.
- Accurate assignment of IN and OUT points is not always possible for variable bit rate (VBR) MP3 files.

Changing the playback speed (VSA)

The unit features the VSA (Variable Speed Audition) function that changes the playback speed without changing its pitch.

CAUTION

The VSA function cannot be effective for files recorded with a sampling frequency of 96kHz, and **SPEED** will be shown in the Home Screen. However, the setting of playback speed can be changed. To apply the adjustment of playback speed, select a file recorded with a sampling frequency of 44.1 kHz or 48 kHz by using the **◀◀** or **▶▶** button.

Press the + or – button after opening the Playback Control screen to increase or decrease the playback speed.

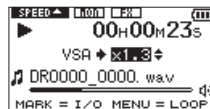

The VSA function can change the playback speed in the range from 0.5 (50%) to 1.5 (150%) times (in 0.1 increments) the normal speed.

Press the **PB CONT** button to the Home Screen while maintaining the set playback speed effective. The **SPEED** or **SPEED** icon appears if the playback speed is set to a value larger or smaller than 1.0, respectively.

6-Playback

Using the playback equalizer (PLAY EQ)

You can choose from different sound types to enhance the listenability (PLAY EQ: playback equalizer).

Set the playback equalizer in the PLAY SETTING screen.

- 1 Press the **MENU** button to open the MENU screen.
- 2 Use the **+** or **-** button to select PLAY SETTING, and press the **▶** button.
PLAY SETTING screen appears.
- 3 Use the **+** or **-** button to select PLAY EQ, and press the **▶▶** or **▶** button.

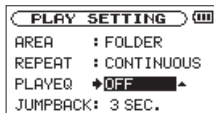

- 4 Use the **+** or **-** button to set the equalizer. **TREBLE**, **MIDDLE**, and **BASS** indicate that adjustment in the high, middle, or low frequency range is enabled, and **+** and **-** indicate that the sound level in that range is increased or decreased, respectively.

Options: OFF (factory setting), TREBLE +, TREBLE -, MIDDLE +, MIDDLE -, BASS +, BASS -

- 5 When finished, press the **⏏** / **|** (HOME) [**■**] button to return to the Home Screen.

Moving back a few seconds for replay (jump-back playback)

Press the ► button during playback to move back a few seconds (adjustable) and restart playback. (Jump-back playback).

If you find a favorite passage of music or lyrics during playback, press the Playback button to go back a few seconds and replay that passage.

The jump-back time is set as a JUMPBACK setting.

1 Press the MENU button to open the MENU screen.

2 Use the + or – button to select PLAY SETTING, and press the ► button.

PLAY SETTING screen appears.

3 Use the + or – button to select JUMPBACK, and press the ► or ►► button.

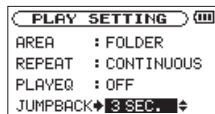

4 Use the + or – button to set the jump-back time.

The setting options include 1 sec (1 second) to 10 sec (10 seconds) in increments of 1 second, and 20 sec (20 seconds), and 30 sec (30 seconds) (default: 3 sec).

5 When finished, press the ⏻ / | (HOME) [■] button to return to the Home Screen.

7-Quick Operations

Features of the QUICK button

The **QUICK** button serves for the following purposes.

- While the Home Screen is open and when stopped or paused, opens the Quick menu screen for deletion, division, and level alignment (enhancing the perceived overall sound pressure) of the current track. During playback, the Quick menu screen appears only for level alignment.
- While the Home Screen is open during recording standby, the Quick menu screen appears for the setting of level control or the left-right channels for the built-in stereo microphones.
- While the Home Screen is open during recording, track increment occurs to stop recording on the current file and continue recording on a new file. (See “Manual track incrementation during recording” on page 68.)

The Quick menu screen will not appear in this case.

- A pop-up menu to work with a selected file or folder appears if the **BROWSE** screen or the **PLAYLIST** screen is open.
- Switches **CALIB** and **INPUT LEVEL** on the **TUNER** screen.

NOTE

The **QUICK** button is disabled if the **MENU** screen, **OTHERS** submenu, **REC SETUP** screen, or a settings screen is open for various settings.

Actions of the **QUICK** button for different screens and states are as follows.

Screen	State	Action
Home	Stop Pause	Opens Quick menu for deletion, division, and level alignment
	Playback	Opens Quick menu only for level alignment
	Recording Standby	Opens Quick menu for level control and MIC LR swap
	Recording	Creates a new file for continued recording (track increment)
Playback Control		Opens Quick menu only for level alignment
BROWSE, PLAY- LIST		Opens pop-up menu for working with selected file (or folder)
TUNER		Switches CALIB and INPUT LEVEL
MENU screen, OTHERS submenu, Other settings screens		—

Quick menu screen

To show the Quick menu screen, press the **QUICK** button while the Home Screen is open. The contents of this screen depend on the state of the unit at the time when the **QUICK** button is pressed.

- **When stopped with the Home Screen open**
Deletion, division, and level alignment of the current track can be selected.

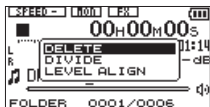

DELETE: The current track can be deleted.
(See “Deleting the selected file (Quick Delete)” on page 97.)

DIVIDE: The current track can be divided.
(See “Dividing the selected file (Divide)” on page 97.)

LEVEL ALIGN: The perceived overall sound pressure can be increased to enhance listenability.

(See “Increasing the perceived overall sound pressure to enhance listenability (Level Alignment)” on page 99.)

- **During playback with the Home Screen open, or while the Playback Control screen is open**

Only level alignment can be selected.

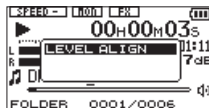

- **During recording standby with the Home Screen open**

You can select the settings of level control or left-right channels for the built-in stereo microphones.

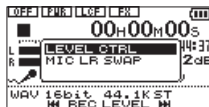

7-Quick Operations

Select LEVEL CTRL, and press the ► button to open the level control setting pop-up window.

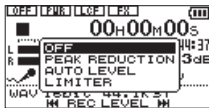

In this window, you can choose from the following three level control options.

PEAK REDUCTION:

When the input sound is too large, the recording volume is decreased automatically to an appropriate level.

AUTO LEVEL:

When the input sound is too small or too large, the recording volume is increased or decreased, respectively, automatically to an appropriate level.

LIMITER:

This prevents distortion of sound due to sudden excessive input.

For details of the level control function, see “Using the Level Control Function” on page 57.

When Monitor Mix is enabled, the input level can be adjusted in a simple way using the I◀◀ or ▶▶I button.



Press the I◀◀ or ▶▶I button to open the input level setting pull-up window. Adjust the input level while checking the input sound. (See “Adjusting the input level” on page 55.)

NOTE

- This is a simple adjustment function for Monitor Mix. During this adjustment, the level meters are hidden and the input level for recording cannot be adjusted accurately. Accurate adjustments should be made when in recording standby. (See “Adjusting the input level” on page 55.)
- The input level cannot be changed if the level control function is set to **AUTO LEVEL**.

Closing the Quick menu screen

Press the **QUICK** button to close the Quick menu screen.

Deleting the selected file (Quick Delete)

The currently selected file can be deleted without using the **BROWSE** screen.

- 1 To delete a file, select it using the **◀◀** or **▶▶** button or the **BROWSE** screen.
- 2 Open the Quick menu screen by pressing the **QUICK** button while the Home Screen is open when stopped.

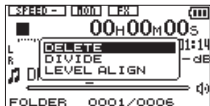

- 3 Use the **+** or **-** button to select **DELETE**.
- 4 Press the **▶** button. A confirmation screen

for file deletion appears.



Press the **▶** button to delete the file, or press the **⏻** / **|** (**HOME**) [**■**] button to cancel the deletion.

Dividing the selected file (DIVIDE)

A recorded file can be divided into two at a specified position.

- 1 Select a file to be divided using the **◀◀** or **▶▶** button or the **BROWSE** screen.
- 2 While the Home Screen is open when stopped, press the **QUICK** button to show the Quick menu screen.

7-Quick Operations

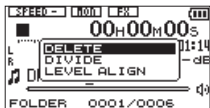

- 3 Use the + or – button to select **DIVIDE**, and press the ► button.

DIVIDE screen appears.

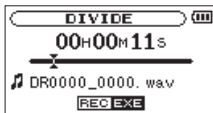

- 4 Use the + or – button to select to specify the position for file division, and press the **RECORD** [●] button.

The following pop-up window appears.

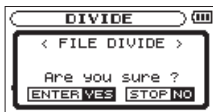

- 5 Press the ► button to divide the file. Or press the ⏪ / | (HOME) [■] button to return to the **DIVIDE** screen without dividing the file.

NOTE

- When the **DIVIDE** screen is open, you can press the ► button and set the divide position while playing the track.
- When the **DIVIDE** screen is open, press the ► button to pause/resume playback and press the ◀◀ or ▶▶ button to move to the beginning or the end of the track. Adjust the position for file division using the + or – button. Press and hold the + or – button to move the position continuously.
- After dividing a file, two new files with “_a” and “_b” added to the end of the original file name are created. For example if the original filename is “DR0000_0000.wav” then the new files will be named “DR0000_0000_a.wav” (the recording before the division point) and “DR0000_0000_b.wav” (the recording after the division point).

CAUTION

- MP3 files cannot be divided.
- If the microSD card has insufficient open space, division might not be possible.
- Division is not possible if the file name would become more than 200 characters long.
- Division is not possible if a file that already exists has the same name as the name that would be given to a new file created by division.

TIP

Add marks during recording at positions where you want to divide a file. (See “Mark function” on page 70.)

Increasing the perceived overall sound pressure to enhance listenability (Level Alignment)

If the playback sound is very small and indiscernible, the perceived overall sound pressure can be increased to enhance listenability. (Level Alignment)

- 1 While the Home Screen is open when stopped or playing back, press the QUICK button to open the Quick menu screen.



When stopped



During playback

- 2 Use the + or – button to select LEVEL ALIGN and press the ► button.

7-Quick Operations

- 3 A screen to enable/disable the level alignment function appears.

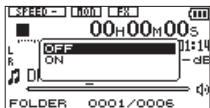

- 4 Use the + or – button to select **ON**, and press the ► button to enable the level alignment function.

Or select **OFF** and press the ► button to disable the level alignment function.

NOTE

The level alignment function may not be able to achieve sufficient effect depending on the source of the sound (example: a music file whose sound pressure has been already adjusted).

8-Using the Effects

The DR-07MKII has built-in effects that can be applied to the input signal during recording and practice. They can also be applied to the output signal during playback.

The **FX** icon appears as light letters on a dark background.

Effects ON indication

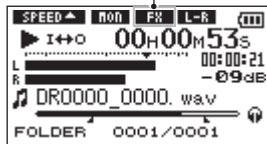

Setting the effect

- 1 Press the **MENU** button to open the **MENU** screen.
- 2 Use the **+ or -** button to select **OTHERS**, and press the **▶** button to open the **OTHERS** submenu.

- 3 Use the **+ or -** button to select **EFFECT**, and press the **▶** button.

The **EFFECT** screen appears.

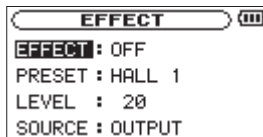

As shown in the above illustration, there are four setting items on the **EFFECT** screen.

Set each item using the **◀◀** or **▶▶** buttons or **+ or -** buttons.

EFFECT:

Use this to turn the effect on or off.

The default setting is **OFF**.

PRESET:

See the Effects Preset List on page 102 for details about the preset effects.

8—Using the Effects

LEVEL:

Use this to change the output level of the preset effect selected in the PRESET item.

Setting range: 0 - 20

SOURCE:

Use this to set whether the effect is applied to the input signal (INPUT) or the output signal (OUTPUT).

The default setting is OUTPUT.

- 4 Use the + or – button to select the desired item and press the ► button or ►► button to access that item's settings.**
- 5 Use the + or – button to set the desired value.**
- 6 Press the ◀◀ button when you are done making the setting to return to item selection status.**
- 7 Press the ⏻ / | (HOME) [■] button to return to the Home Screen.**

CAUTION

When the sampling frequency is set to 96 kHz, or a WAV file with a sampling frequency of 96 kHz is played, the built-in effects do not work.

However, you can still set the built-in effects.

Effects Preset List

Preset name	Effects
HALL 1 (Default)	This is a bright reverb modeled after a large hall-like space.
HALL 2	This is a warm reverb modeled after a large hall-like space.
ROOM	This reverb is modeled on a small indoor space.
STUDIO	This reverb is modeled on a studio-like space.
PLATE 1	This is a bright plate reverb.
PLATE 2	This is a warm plate reverb.

9-Tuning a Musical Instrument (Tuner)

TASCAM DR-07MKII has a built-in tuner. The unit receives a sound from a musical instrument and allows you to tune it accurately on the tuning meter shown in the display.

Using the tuner

Setting the tuner

- 1 Press the **MENU** button to open the **MENU** screen.
- 2 Use the **+** or **-** button to select **OTHERS**, and press the **▶** button to open the **OTHERS** submenu.
- 3 Use the **+** or **-** button to select **TUNER**, and press the **▶** button.

TUNER screen appears.

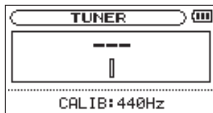

The **TUNER** screen contains the **CALIB** option to set the fundamental frequency of the A. Press the **◀◀** or **▶▶** button to decrease or increase the fundamental frequency. Setting range: 435Hz - 445Hz (in 1Hz increments, default: 440Hz)

Tuning a musical instrument

- 1 Open the **TUNER** screen, and sound a note near the unit.
- 2 Tune the instrument so that the target pitch name appears and the center of the tuner lights.

A bar appears on the left or right of the center if the sound is lower or higher than the target pitch. The bar becomes longer as the sound shifts away from the target pitch.

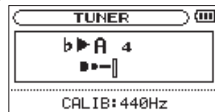

Adjusting the input level for tuning

- 1 Press the **QUICK** button to switch **CALIB** to **INPUT LEVEL** in the bottom of the **TUNER** screen.
- 2 Use the **◀◀** or **▶▶** button to adjust the input level. The pull-up display appears to show the input level setting. See "Manually adjusting the input level" on page 55 for the adjustment operation.

10—Connecting with a computer

By connecting this unit with a computer using the USB cable, you can transfer audio files on the microSD card in the unit to a computer, as well as transfer audio files on the computer to the microSD card in the unit.

This unit can handle audio files of the following formats.

MP3: 32k-320kbps, 44.1k/48kHz

WAV: 44.1k/48k/96kHz, 16/24 bit

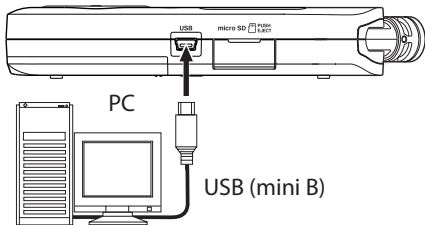

NOTE

Instead of using USB to connect the DR-07MKII and a computer, you can also conduct the same operations by removing the microSD card from the DR-07MKII and

connecting it directly to a computer that has a built-in microSD card slot or by using a card reader.

CAUTION

- You cannot use this unit's other functions when it is connected to a computer by USB.
- The unit should be connected directly with the computer instead of via a USB hub.

When the unit is connected through USB after being turned on, or when the unit is turned on after being connecting through USB, the USB SELECT screen appears to choose between bus power supply or data transmission through USB.



Use the + or – button to select STORAGE, and press the ► button to connect the unit with the computer for data transmission. The message of “USB connected” appears in the display.

10-Connecting with a computer



Make sure that the microSD card is inserted properly.

NOTE

If the USB cable is connected to the unit when batteries has been installed, the power is supplied from the USB port (USB bus power prioritized).

If a microSD card is not properly inserted before making the USB connection, "Can't Save Data" appears on the screen.

This unit appears on the computer screen as external volume named "DR-07MK2."

Transferring files to a computer

- 1 Click the "DR-07MK2" drive on the computer screen to show the "MUSIC" and "UTILITY" folders.
- 2 Open the "MUSIC" folder and drag and drop the files that you want to transfer to the computer to destinations of your choice.

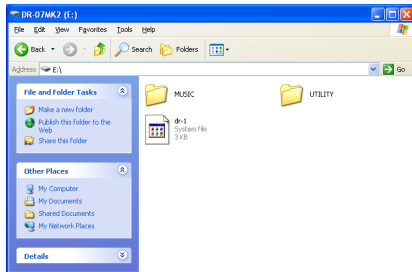

10–Connecting with a computer

Transferring files from a computer

- 1 Click the “DR-07MK2” drive on the computer screen to show the “MUSIC” and “UTILITY” folders.
- 2 Drag and drop files on the computer that you want to transfer to the unit to the “MUSIC” folder.

TIP

- You can manage the MUSIC folder from the computer.
- You can create subfolders in the MUSIC folder up to the second level for use with this unit. The DR-07MKII cannot recognize subfolders and audio files on the third level or below.
- Since you can set the DR-07MKII to only play the contents of a specific folder, you can organize tracks into genres, artists or other categories as you like.
- If you name the subfolders and music tracks, these names will appear on the screen of this unit.

Disconnecting from a computer

Before disconnecting the USB cable, use the proper procedures for your computer to unmount the “DR-07MK2” (as an external drive). The power turns off after disconnecting the USB cable.

See the computer’s operation manual for instructions about how to unmount an external drive.

11—Settings and Information

Viewing File Information

Use the Information Screen to view various types of information about your DR-07MKII.

- 1 Press the **MENU** button to open the **MENU** screen.
- 2 Use the **+** or **-** button to select **OTHERS**, and press the **▶** button to open the **OTHERS** submenu.
- 3 Use the **+** or **-** button to select **INFORMATION**, and press the **▶** button.

The **INFORMATION** screen contains the following three pages. Use the **+** or **-** button to move through the pages.

File information page (FILE)

Shows information about the currently loaded file.

Card information page (CARD)

Shows the use status of the currently inserted microSD card.

System information page (SYSTEM)

Shows the unit's system setting information and firmware version.

File information page

The **FILE** page shows information about the currently selected file.

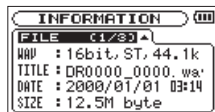

WAV or MP3

Shows the audio file type.

For WAV files, bit length, stereo/mono, and sampling frequency (Hz) also appear.

For MP3 files, the bit rate (kbps), CBR (constant bit rate) or VBR (variable bit rate) type, and sampling frequency (Hz) also appear.

TITLE

Shows the file name. If an MP3 file has ID3 tag title information that information appears.

DATE

Date of file creation

SIZE

File size

11-Settings and Information

Card information page

The CARD page shows the status of the currently inserted microSD card.

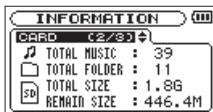

TOTAL MUSIC

Shows the number of playable files contained by the Music Folder.

TOTAL FOLDER

Shows the total number of folders in the Music Folder.

TOTAL SIZE

Shows the total microSD card capacity.

REMAIN SIZE/USED SIZE

Shows the amount of unused/used capacity on the microSD card.

Press the **◀◀** or **▶▶** button to switch between **REMAIN SIZE** and **USED SIZE**.

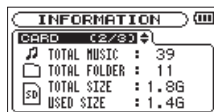

System information page

The SYSTEM page shows information about the DR-07MKII's system settings and firmware version.



AUTO OFF

Shows the automatic power OFF setting.

BACKLIGHT

Shows the automatic backlight OFF setting.

BATTERY

Shows the battery type options.

System Ver.

Shows the system firmware version.

System Settings and Formatting

From the SYSTEM Screen, you can change various settings to optimize the device for your use environment and other requirements. You can also initialize the unit and format the microSD card.

- 1 Press the MENU button to open the MENU screen.
2. Use the + or – button to select OTHERS, and press the ► button to open the OTHERS submenu.
3. Use the + or - button to select SYSTEM, and press the ► button.

SYSTEM screen appears.

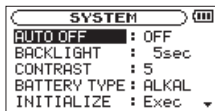

The following settings can be made for the items on the SYSTEM screen.

Use the ◀◀ or ▶▶ button and the + or – button to set each item.

Turning the unit power OFF automatically

Use the AUTO OFF item to set the time before the unit power automatically turns OFF after the last activity or use when powered by the battery.

Options: OFF (factory setting—the unit does not automatically turn OFF), 3 min, 5 min, 10 min, 30 min

Setting the backlight

Use BACKLIGHT to set the time until the backlight automatically turns OFF after the last operation when powered by the internal battery.

Options: OFF (turned off), 5 sec (factory setting), 10 sec, 15 sec, 30 sec, ALWAYS (always on)

11—Settings and Information

Adjusting the display contrast

Use **CONTRAST** to adjust the display contrast.

Options: 1–20 (factory setting: 5)

Setting the type of AA batteries

Use **BATTERY TYPE** to set the type of the AA batteries that you are using. This setting is used to show the amount of remaining battery charge and determine if the unit has enough power for normal operation.

Values: **ALKAL** (alkaline batteries, default), **Ni-MH** (nickel-metal hydride batteries)

Restoring the factory settings

Use the **INITIALIZE** item to restore the various settings of this unit to their factory settings.

- 1 Use the **+ or –** button to select **INITIALIZE**, and press the **▶** button to highlight **Exec.**
- 2 Press the **▶** button again to open a

confirmation pop-up window.

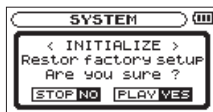

- 3 Press the **▶** button to initialize the unit. Press **⏻ / | (HOME) [■]** to cancel initialization.

Using QUICK FORMAT

Using **QUICK FORMAT** erases all music files on the card and automatically creates new "MUSIC" and "UTILITY" folders as well as the "dr-1.sys" file that is necessary to use the microSD card with the DR-07MKII.

- 1 Use the **+ or –** button to select **QUICK FORMAT**, and press the **▶** button to highlight **Exec.**
- 2 Press the **▶** button to open a pop-up confirmation window.



- 3 Press the ► button to execute the quick formatting, or press the ⏪ / | (HOME) [■] button to cancel formatting.

Using FULL FORMAT

Use the FULL FORMAT item to completely format the microSD card.

Full formatting checks the memory for errors while formatting, so it takes more time than quick formatting.

Using FULL FORMAT erases all music files on the card and automatically creates new "MUSIC" and "UTILITY" folders as well as the "dr-1.sys" file that is necessary to use the microSD card with the DR-07MKII.

- 1 Use the + or – button to select FULL FORMAT, and press the ► button to

highlight Exec.

- 2 Press the ► button to open a pop-up confirmation window.

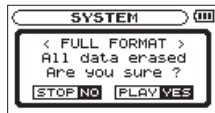

- 3 Press the ► button to execute the full formatting, or press the ⏪ / | (HOME) [■] button to cancel formatting.

CAUTION

When formatting a card, the unit should be operating on AC power supplied through the PS-P515U adapter (sold separately), USB bus power supplied from a computer, or batteries with sufficient remaining power. If the power fails during formatting, the formatting may not occur correctly.

11—Settings and Information

Setting the format of file names

You can select the format of names given to files recorded by this unit.

- 1 Press the **MENU** button to open the **MENU** screen.
- 2 Use the **+** or **-** button to select **OTHERS**, and press the **▶** button to open the **OTHERS** submenu.
- 3 Use the **+** or **-** button to select **FILE NAME**, and press the **▶** button.

FILE NAME screen appears.

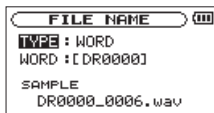

Use the **◀◀** or **▶▶** button and the **+** or **-** button to set each item.

On this screen you can make the following settings for each item.

File name format

The **TYPE** item can be set to either **WORD** (default setting) or **DATE**.

WORD: When set to **WORD**, a 6-character file name is used as the beginning of each file name.

Example: DR0000_0000.wav

DATE: The date is used as the file name (in **yymmdd** format).

Example: 110101_0000.wav

NOTE

The date is set using the unit's internal clock. (See "Setting the date and time" on page 42.)

Setting the **WORD** item

To set the **WORD** item, use the **◀◀** and **▶▶** buttons to move the cursor, and use the **+** or **-** button to select the character.

In addition to the alphabet and numbers, the following characters can be used:

! # \$ % & ' () + , - . ; = @ [] ^
_ ` { } ~

12–Messages

The following is a list of the popup messages that might appear on the DR-07MKII under certain conditions. Refer to this list if one of these popup messages appears and you want to check the meaning or determine a proper response.

Message	Meaning and response
File Name ERR	The DIVIDE function would cause the file name to exceed 200 characters. The DIVIDE function adds "_a" or "_b" to the end of the file name. Before choosing the DIVIDE function, connect the unit to a computer and edit the file name to less than 198 characters.
DUP File Name	The DIVIDE function would cause the file name to be the same as that of an existing file. The DIVIDE function adds "_a" or "_b" to the end of the file name. Before choosing the DIVIDE function, connect the unit to a computer and edit the file name.
File Not Found	The file added to the playlist cannot be found or a file could be damaged. Please check the file in question.
Non-Supported	The audio file is not a supported format. Please see "10–Connecting with a computer" for file formats that this unit can use.
Battery Empty	The battery is almost out of power. Replace the AA batteries.
I/O Too Short	The IN and OUT points are too close together. Reset the IN and OUT points with at least 1 second between them.
File Not Found PLAYLIST	The file in the Playlist cannot be found. Please confirm that the file is still in the Music Folder.
No PLAYLIST	No files have been added to the Playlist. Add a file to the Playlist or change the play mode to something besides PLAYLIST.
PLAYLIST Full	The playlist is full. You cannot add more than 99 tracks to the Playlist.

12–Messages

Message	Meaning and response
MBR Error Init CARD	The card is not formatted properly or the formatting is broken. Change the card or press the ► button when this message appears to format the card in FAT format. CAUTION: <i>Execution of FAT formatting erases all data currently on the card.</i>
Format Error Format CARD	The FAT formatting of the card is abnormal or broken. This message also appears if you FAT formatted the card using a computer connected by USB and if a new card is inserted in the unit. Always use the DR-07MKII to conduct FAT formatting of cards to be used with it. Change the card or press the ► button when this message appears to format the card in FAT format. CAUTION: <i>Execution of FAT formatting erases all data currently on the card.</i>
File Not Found Make Sys File	The system file is missing. This unit requires a system file for operation. When this message appears, press the ► button to automatically create a system file.
Invalid SysFile Make Sys File	The system file required to operate this unit is invalid. When this message appears, press the ► button to automatically create a system file.
Invalid Card Change Card	Something might be wrong with the card. Change the card.
Write Timeout	Writing to the card timed out. Backup files on the card to your computer, and format the card.
Card Full	The card has no remaining capacity. Erase unnecessary files or move them to your computer to make open space.
Layer too Deep	Folders can be created down to two layers. You cannot create a new folder inside the current folder.

Message	Meaning and response
Can't Divide	The position selected for divide is not suitable (too close to the beginning or end of a track).
Max File Size	The file is larger than the designated size or the recording time exceeded 24 hours.
File Full	The total number of folders and files exceeds 5000. Erase unnecessary files or move them to your computer.
Card Error	The card could not be handled properly. Replace the card.
Current File MP3	MP3 files cannot be divided.
File Protected	The file is read only and cannot be erased.
No Card	No card is in the unit, so recording is not possible.
No PB File	There is no file that can be played back. The file might be damaged.
No MUSIC File	There is no playback file, so DIVIDE and OVERDUB cannot be executed.
Cannot overdub! See REC setting	You cannot overdub a WAV file with a sampling frequency of 96kHz in MP3 format. Change the recording format to WAV.

12–Messages

Message	Meaning and response
Not Continued	<p>If any of these errors occurs, turn the unit's power off and restart it. If the power cannot be turned off, remove the batteries, disconnect the AC adaptor (TASCAM PS-P515U), and/or disconnect the USB cable for bus power supply. If the error message continues to appear frequently, please contact a TEAC Repair Center.</p>
File Error	
Can't Save Data	
Player Error	
Device Error	
Writing Failed	
Sys Rom Err	
Remote Cmd	
Remote Rx	
System Err 50	
System Error 1	
System Error 2	
System Error 3	
System Error 4	
System Error 5	
System Error 6	
System Error 7	
System Error 8	
System Error 9	

13–Troubleshooting

If you are having trouble with the operation of this unit, please try the following before seeking repair. If these measures do not solve the problem, please contact the store where you bought the unit, an authorized distributor or a TASCAM Customer Support.

■ Power will not turn ON.

- Confirm that the batteries are not dead.
- Confirm that the batteries are installed with the correct +/- orientation.
- Confirm that the AC adapter (TASCAM PS-P515U, sold separately) is firmly connected to both the socket and the unit.
- Confirm that the USB cable (if used for USB bus power supply) is firmly connected.
- Confirm that the USB cable (if used for USB bus power supply) is not connected via a USB hub.

■ The unit does not function.

- Confirm that the **HOLD** switch is not set in the direction of the arrow.

- Is the unit connected to a PC with the USB cable? (Is **USB connected** shown on the display?)

■ The microSD card is not recognized.

- Confirm that the microSD card is inserted completely.

■ Playback does not work.

- If you are trying to play a WAV file, confirm that the sampling frequency is supported by this unit.
- If you are trying to play an MP3 file, confirm that the bit rate is supported by this unit.

■ The speakers do not work.

- Are headphones connected?
- Is **SPEAKER** set to **OFF**?
- Check the connections with the monitoring system.
- Is the volume of the monitoring system minimized?

13–Troubleshooting

- Is the OUTPUT LEVEL setting of the unit minimized?

■ Recording does not work.

- If you are using an external device, check the connection again.
- Check the input settings again.
- Confirm that the recording level is not too low.
- Confirm that the microSD card is not full.
- Confirm that the number of files has not reached the maximum that the unit can handle.

■ The recording level is low.

- Confirm that the input level setting is not too low.
- Confirm that the output level of a connected external device is not too low.

■ The sound I am trying to record sounds distorted.

- Confirm that the input level setting for recording (REC LEVEL) is not too high.

- Do the built-in effects work?

■ The playback sounds unnatural.

- Confirm that the playback speed is not being adjusted.
- Confirm that the playback equalizer is not enabled.
- Confirm that the level alignment function is not enabled.
- Do the built-in effects work?

■ I cannot erase a file.

- Confirm that you are not trying to erase a file that has been copied from a computer after being write-protected.

■ This unit's files do not appear on the computer.

- Confirm that the unit is connected to the computer using its USB port.
- Confirm that USB hubs are not used.
- Confirm that the unit is not recording or in recording standby mode.

Ratings

Recording media

microSD card (64 MB - 2 GB)

microSDHC card (4 GB - 32 GB)

Recording/playback format

WAV: 44.1/48/96 kHz, 16/24-bit

MP3: 44.1/48 kHz, 32/64/96/128/192/256/320 kbps

Number of channels

2 channels (stereo)

Input/output ratings

Analog audio input/output ratings

MIC/EXT IN jacks (supporting plug-in power)

Connector: 1/8" (3.5 mm) stereo mini

Input impedance: 25 k Ω

Nominal input level: -20 dBV

Maximum input level: -4 dBV

Ω /LINE OUT

Connector: 1/8" (3.5 mm) stereo mini

Output impedance: 12 Ω

Nominal output level: -14 dBV (10 k Ω load)

Maximum output level: +2 dBV (10 k Ω load)

Maximum output: 20 mW + 20 mW (32 Ω load)

Built-in speaker

0.3 W (monaural)

Control input/output ratings

USB jack

Connector: Mini-B type

Format: USB 2.0 HIGH SPEED mass storage class

14-Specifications

Audio performance

Frequency response

20 - 20 kHz +1/-3 dB

(44.1 kHz, EXT IN to LINE OUT) (JEITA)

20 -22 kHz +1/-3 dB

(48 kHz, EXT IN to LINE OUT) (JEITA)

20 - 40 kHz +1/-3 dB

(96 kHz, EXT IN to LINE OUT) (JEITA)

Total harmonic distortion

0.05% or lower (EXT IN to LINE OUT, Fs

44.1/48/96kHz) (JEITA)

S/N ratio

92dB or higher (EXT IN to LINE OUT, Fs

44.1/48/96kHz) (JEITA)

Note) JEITA: Conforming to JEITA CP-2150

Computer compatibility

Windows

Pentium 300 MHz or faster

128 MB or more memory

USB port (USB 2.0 recommended)

Macintosh

Power PC, iMac, G3, G4 266 MHz or faster

64 MB or more memory

USB port (USB 2.0 recommended)

Recommended USB host controller

Intel chipset

Supported OS

Windows XP, Windows Vista, Windows 7

Macintosh Mac OS X 10.2 or later

Other specifications

Power

Two AA batteries (Alkaline or Ni-MH)
 USB bus power supplied from a computer
 AC adaptor (TASCAM PS-P515U, sold separately)

Power consumption

1.7 W (maximum)

Battery operation time (continuous operation)

Alkaline type battery (EVOLTA)

Recording/ playback	Format	Operation time	Note
Recording	WAV 96KHz, 24bit	About 10.5 hours	Built-in microphone
Recording	WAV 44.1KHz, 16bit	About 17.5 hours	Built-in microphone
Recording	MP3 44.1KHz, 128Kbps	About 16 hours	Built-in microphone
Recording	MP3 48 KHz, 320Kbps	About 11 hours	Built-in microphone
Playback	WAV 96KHz, 24bit	About 17 hours	Headphones

Recording/ playback	Format	Operation time	Note
Playback	WAV 96KHz, 24bit	About 17 hours	Built-in Speaker
Playback	WAV 44.1KHz, 16bit	About 19.5 hours	Headphones
Playback	WAV 44.1KHz, 16bit	About 19.5 hours	Built-in Speaker
Playback	MP3 44.1KHz, 128Kbps	About 19.5 hours	Headphones
Playback	MP3 44.1KHz, 128Kbps	About 18.5 hours	Built-in Speaker
Playback	MP3 48 KHz, 320Kbps	About 19.5 hours	Headphones
Playback	MP3 48 KHz, 320Kbps	About 18.5 hours	Built-in Speaker

Ni-MH type battery (eneloop)

Recording/ playback	Format	Operation time	Note
Recording	WAV 96KHz, 24bit	About 10 hours	Built-in microphone
Recording	WAV 44.1KHz, 16bit	About 15.5 hours	Built-in microphone
Recording	MP3 44.1KHz, 128Kbps	About 13 hours	Built-in microphone

14-Specifications

Recording/ playback	Format	Operation time	Note
Recording	MP3 48 KHz, 320Kbps	About 11 hours	Built-in microphone
Playback	WAV 96KHz, 24bit	About 15 hours	Headphones
Playback	WAV 96KHz, 24bit	About 14 hours	Built-in Speaker
Playback	WAV 44.1KHz, 16bit	About 16.5 hours	Headphones
Playback	WAV 44.1KHz, 16bit	About 16.5 hours	Built-in Speaker
Playback	MP3 44.1KHz, 128Kbps	About 16 hours	Headphones
Playback	MP3 44.1KHz, 128Kbps	About 15 hours	Built-in Speaker
Playback	MP3 48 KHz, 320Kbps	About 16 hours	Headphones
Playback	MP3 48 KHz, 320Kbps	About 15 hours	Built-in Speaker

Weight

127 g (4 7/16 oz) (not including batteries)

Operating temperature range

0 - 40°C (32°F - 104°F)

Dimensions (W x H x D)

68 x 158 x 26 mm (2 5/8" x 6 3/16" x 1")
(when the microphone pair is close)

90 x 158 x 26 mm (3 1/2" x 6 3/16" x 1")
(when the microphone pair is open)

Dimensional drawings

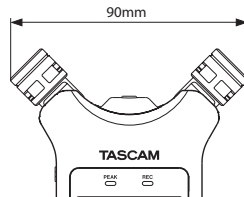
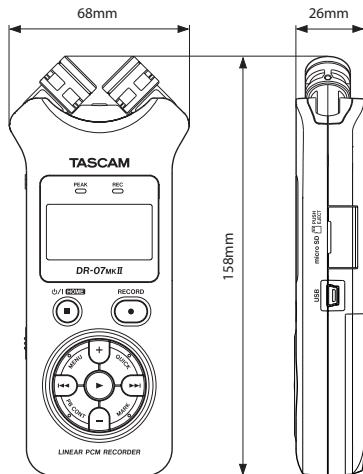

Dimension of the microphone opened

- Illustrations and other depictions may differ in part from the actual product.
- Specifications and external appearance may be changed without notification to improve the product.

TASCAM

DR-07MKII

TEAC CORPORATION

Phone: +81-42-356-9143

1-47 Ochiai, Tama-shi, Tokyo 206-8530 Japan

<http://tascam.jp/>

TEAC AMERICA, INC.

Phone: +1-323-726-0303

7733 Telegraph Road, Montebello, California 90640 USA

<http://tascam.com/>

TEAC CANADA LTD.

Phone: +1905-890-8008 Facsimile: +1905-890-9888

5939 Wallace Street, Mississauga, Ontario L4Z 1Z8, Canada

<http://tascam.com/>

TEAC MEXICO, S.A. de C.V.

Phone: +52-55-5010-6000

Rio Churubusco 364, Colonia Del Carmen, Delegación Coyoacán, CP 04100, México DF, México

<http://www.teacmexico.net/>

TEAC UK LIMITED

Phone: +44-8451-302511

Suites 19 & 20, Building 6, Croxley Green Business Park, Hatters Lane, Watford, Hertfordshire. WD18 8TE, U.K.

<http://www.tascam.co.uk/>

TEAC EUROPE GmbH

Phone: +49-611-71580

Bahnstrasse 12, 65205 Wiesbaden-Erbenheim, Germany

<http://tascam.de/>
